

# Vacuum generators

**FESTO**



Festo core product range  
Covers 80% of your automation tasks

Worldwide:

Always in stock

Superb:

Festo quality at an attractive price

Easy:

Reduces procurement and storing complexity



Ready for dispatch from the Festo factory in 24 hours  
Held in stock in 13 service centres worldwide  
More than 2200 products



Ready for dispatch in 5 days maximum from stock  
Assembled for you in 4 service centres worldwide  
Up to  $6 \times 10^{12}$  variants per product series

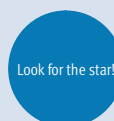

# Vacuum generators

Key features

FESTO

## Product overview

**Vacuum generator**

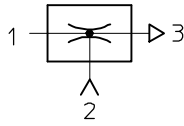

All Festo vacuum generators have a single-stage design and operate according to the venturi principle. The product families described below

have been designed for a wide range of applications. The different performance classes of the individual

product families make it possible to select vacuum generators tailored to suit specific requirements.

## Standard and inline ejectors

VN-...

→ 13

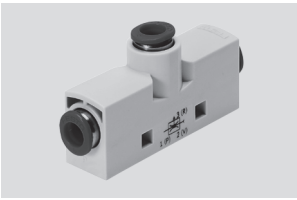

- Nominal size 0.45 ... 3 mm
- Max. vacuum 93%
- Temperature range 0 ... +60 °C
- A range of extremely effective generators suitable for use directly in the workplace
- Available as straight or T-shaped housing
- Low space requirement
- Low-cost
- No wearing parts
- Extremely fast evacuation time
- Vacuum switch (optional)
- Optional with additional functions:
  - integrated eject pulse
  - electric control for vacuum ON/OFF
  - combination of eject pulse and control

VAD-.../VAK-...

Technical data → Internet: vad



- Nominal size 0.5 ... 1.5 mm
- Max. vacuum 80%
- Temperature range -20 ... +80 °C
- Range of vacuum generators with sturdy aluminium casing
- VAK-...: Built-in reservoir
- VAD-...: Connection for additional external reservoir
- Maintenance-free
- VAK-...: Reliable setting down of workpieces

# Vacuum generators

Key features

## Compact ejectors

VADM-.../VADMI-...

Technical data → Internet: vadm



- Nominal size  
0.45 ... 3 mm
- Max. vacuum  
84%
- Temperature range  
0 ... +60 °C
- Compact design
- Minimal installation work required
- Short response times
- Built-in solenoid valve (on/off)
- VADMI-...: Additional built-in solenoid valve for ejector pulse
- Filter with display
- Air-saving function (optional)
- Vacuum switch (optional)
- Reliable setting down of workpieces

VAD-M-.../VAD-M-I-...

Technical data → Internet: vad-m

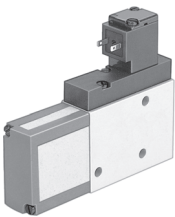

- Nominal size  
0.7 ... 2 mm
- Max. vacuum  
85%
- Temperature range  
0 ... +40 °C
- Compact design
- Minimal installation work required
- Short response times
- Built-in solenoid valve (on/off)
- VAD-M-I-...: Additional built-in solenoid valve for ejector pulse
- Reliable setting down of workpieces

# Vacuum generators VN

## Features

### At a glance

- Vacuum generators for high vacuum levels of up to 93%
- Laval nozzles in six nominal sizes:
  - 0.45 mm
  - 0.7 mm
  - 0.95 mm
  - 1.4 mm
  - 2.0 mm
  - 3.0 mm
- Vacuum generators for high suction rates resulting in very short evacuation times
- Low space requirement
- Compact and sturdy design
- Wear-resistant and maintenance-free
- Modular system: Large selection of different types
- Can be used directly in the workplace, making them very effective
- Plastic housing
- Versatile connection options:
  - Push-in connector QS
  - Screw-in thread
  - Push-in sleeve
  - Screw-in silencer
- Easy mounting thanks to the double-sided latching function of the mounting plate
- With or without integrated vacuum switch to monitor the vacuum with PNP output

### Two housing types

#### Standard T-type

#### Connection options:

- QS push-in connectors
- Female thread
- Male thread
- Silencers

#### Mounting options:

- Direct mounting with screws
- Indirect mounting by latching onto a mounting plate. This plate is suitable for H-rails 35x7.5 to DIN EN 50 022.

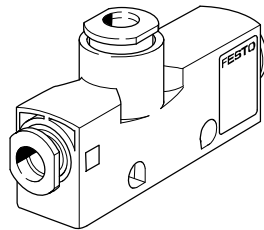

#### In-line version

#### Connection options:

- QS push-in connectors
- Push-in sleeve

#### Mounting options:

Extremely compact housing with supply and vacuum port arranged in a line and with unducted exhaust air. As a result, this housing type can be installed directly into the tubing line.

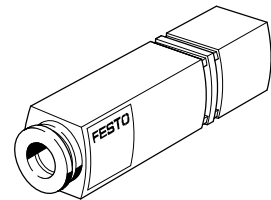

### Two operating principles

#### Standard

- T-type housing

#### Design:

Supply port at 90° to vacuum port. The drawn-in flow is diverted 90° from V to R.

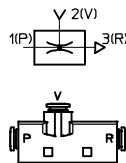

#### In-line

- T-type housing with exhaust port
- Straight housing without exhaust port for space-saving assembly in a tubing line or directly in the suction cup holder

#### Design:

Supply and vacuum ports arranged in-line.

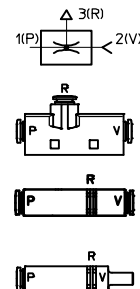

# Vacuum generators VN

Features

## Two variants

High vacuum

up to 93%

Vacuum  $p_u$  as a function of operating pressure  $p_1$

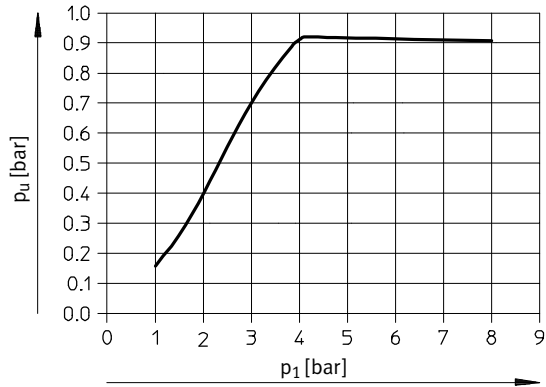

High suction volume

up to 339 l/min which results in very short evacuation times

Suction rate  $q_{ns}$  as a function of operating pressure  $p_1$

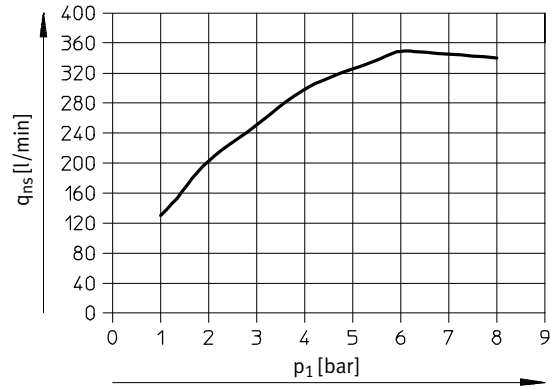

## System comparison

High vacuum – high suction volume

The first type of generator has been optimised for the generation of high vacuum at comparatively lower suction flow rates.

The second type of generator, on the other hand, can achieve very short evacuation times because of the high suction flow rate at relatively low vacuum.

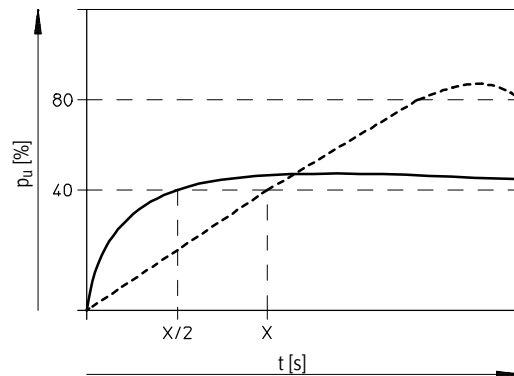

----- High vacuum  
 ——— High suction volume

# Vacuum generators VN

Product range overview



Function	Version	Type	Nominal size of laval nozzle [mm]	Grid dimension									Pneumatic connection 1	
				T-type					Inline				Push-in fitting PQ	Female thread PI
				10 [mm]	14 [mm]	16 [mm]	18 [mm]	24 [mm]	10 [mm]	13 [mm]	14.5 [mm]			
High vacuum	<b>Standard H</b>													
		VN-05-H	0.45	■	-	-	-	-	-	-	-	-	■	■
					-	■	-	-	-	-	-	-	■	■
		VN-07-H	0.7	■	-	-	-	-	-	-	-	-	■	■
					-	■	-	-	-	-	-	-	■	■
		VN-10-H	0.95	-	■	-	-	■	-	-	-	-	■	■
				-	-	-	-	■	-	-	-	-	■	-
		VN-14-H	1.4	-	-	-	-	■	-	-	-	-	■	■
				-	-	-	-	-	-	-	-	-	■	■
		VN-20-H	2.0	-	-	-	-	-	■	-	-	-	■	■
				-	-	-	-	-	-	-	-	-	■	■
		VN-30-H	3.0	-	-	-	-	-	■	-	-	-	■	■
				-	-	-	-	-	-	-	-	-	■	■
	<b>Standard H with integrated vacuum switch</b>													
			VN-05-H-...-P	0.45	-	-	■	-	-	-	-	-	■	-
				VN-07-H-...-P	0.7	-	-	■	-	-	-	-	■	-
				VN-10-H-...-P	0.95	-	-	■	-	-	-	-	■	-
	<b>Standard H with pneumatic ejector pulse</b>													
			VN-05-H-...-A	0.45	-	■	-	-	-	-	-	-	■	■
				VN-07-H-...-A	0.7	-	■	-	-	-	-	-	■	■
				VN-10-H-...-A	0.95	-	-	-	-	-	-	-	■	■
				VN-14-H-...-A	1.4	-	-	-	■	-	-	-	■	■
	<b>Standard H with electrical on-off valve</b>													
			VN-05-H-...-M	0.45	-	■	-	-	-	-	-	-	■	-
			VN-07-H-...-M	0.7	-	■	-	-	-	-	-	■	-	
			VN-10-H-...-M	0.95	-	-	-	-	-	-	-	■	-	
			VN-14-H-...-M	1.4	-	-	-	■	-	-	-	■	-	
			VN-20-H-...-M	2.0	-	-	-	-	■	-	-	■	-	
			VN-30-H-...-M	3.0	-	-	-	-	-	-	-	■	-	
<b>Standard H with electrical on-off valve and pneumatic ejector pulse</b>														
		VN-05-H-...-B	0.45	-	■	-	-	-	-	-	-	■	-	
			VN-07-H-...-B	0.7	-	■	-	-	-	-	-	■	-	
			VN-10-H-...-B	0.95	-	-	-	-	-	-	-	■	-	
			VN-14-H-...-B	1.4	-	-	-	■	-	-	-	■	-	
<b>Inline M</b>														
		VN-05-M	0.45	■	-	-	-	-	-	-	-	■	■	
					-	■	-	-	-	-	-	-	■	-
			VN-07-M	0.7	■	-	-	-	-	-	-	-	■	■
					-	■	-	-	-	-	-	-	■	-
			VN-10-M	0.95	-	-	-	-	-	-	-	■	■	-
					-	-	-	-	-	-	-	-	■	-
<b>Inline M with pneumatic ejector pulse</b>														
		VN-05-M-...-A	0.45	-	-	-	-	-	-	-	-	■	■	
			VN-07-M-...-A	0.7	-	-	-	-	-	-	-	■	-	

# Vacuum generators VN

Product range overview





FESTO

Type	Vacuum connection				Pneumatic connection 3			Switching function		→ Page/ Internet
	Push-in fitting VQ	Female thread VI	Male thread VA	Push-in sleeve VT	Push-in fitting RQ	Female thread RI	Silencer RO	Fixed hysteresis O1	Variable hysteresis O2	
<b>Standard H</b>										
VN-05-H	■	■	- ■	-	■	■	■	-	-	11
VN-07-H	■	■	- ■	-	■	■	■	-	-	
VN-10-H	■	■ -	■	-	■	■ -	■	-	-	
VN-14-H	■	■	■	-	■	■	■	-	-	
VN-20-H	■	■	■	-	-	-	■	-	-	
VN-30-H	■	■	■	-	-	-	■	-	-	
<b>Standard H with integrated vacuum switch</b>										
VN-05-H-...-P	■	-	-	-	-	-	-	■	■	26
VN-07-H-...-P										
VN-10-H-...-P										
<b>Standard H with pneumatic ejector pulse</b>										
VN-05-H-...-A	■	■	-	-	-	-	■	-	-	32
VN-07-H-...-A										
VN-10-H-...-A										
VN-14-H-...-A										
<b>Standard H with electrical on-off valve</b>										
VN-05-H-...-M	■	-	-	-	-	-	■	-	-	32
VN-07-H-...-M										
VN-10-H-...-M										
VN-14-H-...-M										
VN-20-H-...-M										
VN-30-H-...-M										
<b>Standard H with electrical on-off valve and pneumatic ejector pulse</b>										
VN-05-H-...-B	■	-	-	-	-	-	■	-	-	32
VN-07-H-...-B										
VN-10-H-...-B										
VN-14-H-...-B										
<b>Inline M</b>										
VN-05-M	■	■	-	-	■	■	■	-	-	11
	■	-	-	■	-	-	-	-	-	
VN-07-M	■	■	-	-	■	■	■	-	-	
	■	-	-	■	-	-	-	-	-	
VN-10-M	■	-	-	-	-	-	-	-	-	
<b>Inline M with pneumatic ejector pulse</b>										
VN-05-M-...-A	■	-	-	-	-	-	-	-	-	32
VN-07-M-...-A										

# Vacuum generators VN

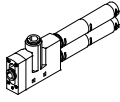
Product range overview

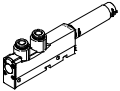
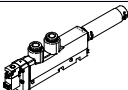
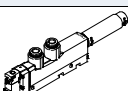
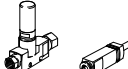
FESTO

Function	Version	Type	Nominal size of laval nozzle [mm]	Grid dimension							Pneumatic connection 1			
				T-type					Inline		Push-in fitting PQ	Female thread PI		
				10 [mm]	14 [mm]	16 [mm]	18 [mm]	24 [mm]	10 [mm]	13 [mm]			14.5 [mm]	
High suction rate	<b>Standard L</b>													
		VN-05-L	0.45	■	-	-	-	-	-	-	-	-	■	■
		VN-07-L	0.7	-	■	-	-	-	-	-	-	-	■	■
		VN-10-L	0.95	-	■	-	-	■	-	-	-	-	■	■
		VN-14-L	1.4	-	-	-	■	-	-	-	-	-	■	■
		VN-20-L	2.0	-	-	-	-	-	■	-	-	-	■	■
		VN-30-L	3.0	-	-	-	-	-	■	-	-	-	■	■
	<b>Standard L with integrated vacuum switch</b>													
		VN-05-L...-P	0.45	-	-	■	-	-	-	-	-	-	■	-
		VN-07-L...-P	0.7	-	-	■	-	-	-	-	-	-	■	-
		VN-10-L...-P	0.95	-	-	-	■	-	-	-	-	-	■	-
	<b>Standard L with pneumatic ejector pulse</b>													
		VN-05-L...-A	0.45	-	■	-	-	-	-	-	-	-	■	■
		VN-07-L...-A	0.7	-	■	-	-	-	-	-	-	-	■	■
		VN-10-L...-A	0.95	-	-	-	■	-	-	-	-	-	■	■
		VN-14-L...-A	1.4	-	-	-	■	-	-	-	-	-	■	■
	<b>Standard L with electrical on-off valve</b>													
		VN-05-L...-M	0.45	-	■	-	-	-	-	-	-	-	■	-
		VN-07-L...-M	0.7	-	■	-	-	-	-	-	-	-	■	-
		VN-10-L...-M	0.95	-	-	-	■	-	-	-	-	-	■	-
		VN-14-L...-M	1.4	-	-	-	■	-	-	-	-	-	■	-
	<b>Standard L with electrical on-off valve and pneumatic ejector pulse</b>													
		VN-05-L...-B	0.45	-	■	-	-	-	-	-	-	-	■	-
		VN-07-L...-B	0.7	-	■	-	-	-	-	-	-	-	■	-
VN-10-L...-B		0.95	-	-	-	■	-	-	-	-	-	■	-	
VN-14-L...-B		1.4	-	-	-	■	-	-	-	-	-	■	-	
<b>Inline N</b>														
	VN-05-N	0.45	-	■	-	-	-	-	-	-	-	■	■	
			-	-	-	-	-	-	-	■	-	■	-	
<b>Inline N with pneumatic ejector pulse</b>														
	VN-05-N...-A	0.45	-	-	-	-	-	-	-	-	■	■	-	
	VN-07-N...-A	0.7	-	-	-	-	-	-	-	-	■	■	-	



# Vacuum generators VN

Product range overview

FESTO

Type	Vacuum connection				Pneumatic connection 3			Switching function		→ Page/ Internet
	Push-in fitting VQ	Female thread VI	Male thread VA	Push-in sleeve VT	Push-in fitting RQ	Female thread RI	Silencer RO	Fixed hysteresis O1	Variable hysteresis O2	
<b>Standard L</b>										
VN-05-L	■	■	- ■	-	■	■	■	-	-	11
VN-07-L	■	■	■	-	■	■	■	-	-	
VN-10-L	■	■ -	■	-	■	■ -	■	-	-	
VN-14-L	■	■	■	-	■	■	-	-	-	
VN-20-L	■	■	■	-	-	-	■	-	-	
VN-30-L	-	■	■	-	-	-	■	-	-	
<b>Standard L with integrated vacuum switch</b>										
VN-05-L-...-P	■	-	-	-	-	-	-	■	■	26
VN-07-L-...-P										
VN-10-L-...-P										
<b>Standard L with pneumatic ejector pulse</b>										
VN-05-L-...-A	■	■	-	-	-	-	■	-	-	32
VN-07-L-...-A										
VN-10-L-...-A										
VN-14-L-...-A										
<b>Standard L with electrical on-off valve</b>										
VN-05-L-...-M	■	-	-	-	-	-	■	-	-	32
VN-07-L-...-M										
VN-10-L-...-M										
VN-14-L-...-M										
<b>Standard L with electrical on-off valve and pneumatic ejector pulse</b>										
VN-05-L-...-B	■	-	-	-	-	-	■	-	-	32
VN-07-L-...-B										
VN-10-L-...-B										
VN-14-L-...-B										
<b>Inline N</b>										
VN-05-N	■	■	-	-	■	■	■	-	-	11
	■	-	-	■	-	-	-	-	-	
<b>Inline N with pneumatic ejector pulse</b>										
VN-05-N-...-A	■	-	-	-	-	-	-	-	-	32
VN-07-N-...-A										

# Vacuum generators VN

Product range overview

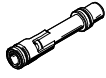
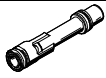
Function	Version	Type	Nominal size of laval nozzle	→ Page/ Internet
			[mm]	
High vacuum	<b>Vacuum generator cartridge, standard H</b>			
		VN-05-H	0.45	43
		VN-07-H	0.7	
		VN-10-H	0.95	
		VN-14-H	1.4	
		VN-20-H	2.0	
High suction rate	<b>Vacuum generator cartridge, standard L</b>			
		VN-05-L	0.45	43
		VN-07-L	0.7	
		VN-10-L	0.95	
		VN-14-L	1.4	
		VN-20-L	2.0	

# Vacuum generators VN

Peripherals overview

FESTO

VN-05/07/10/14  
Inline

T-type

VN-20/30

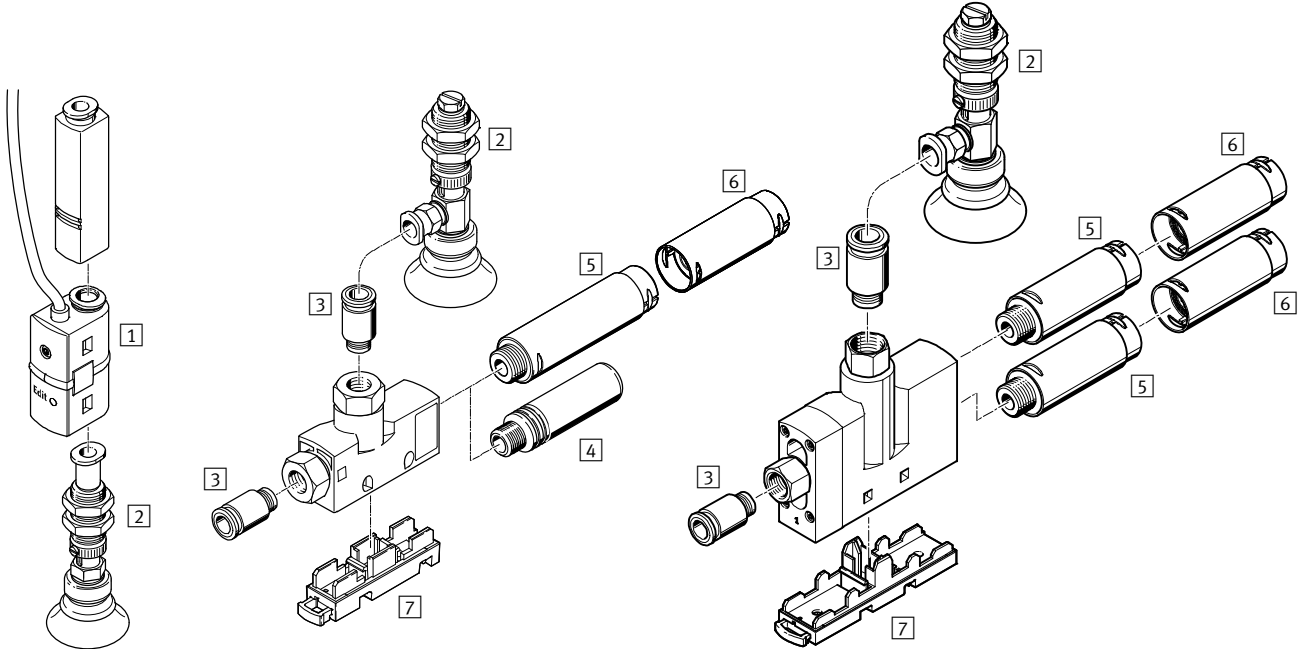

## Mounting attachments and accessories

	VN-05/07/10/14						VN-20/30	→ Page/Internet
	Inline		T-type			T-type		
	10 mm	13 mm	10 mm	14 mm	18 mm	24 mm		
1 Pressure switch SDE5		■			■		■	sde5
2 Suction gripper ESG		■			■		■	esg
3 Push-in fitting QS		-			■		■	qs
4 Silencer UO		-	■	■	■		-	47
Silencer AMTE		-	■	■	■		-	47
5 Silencer UOM		-	-	-	■		■	47
6 Silencer extension UOMS		-	-	-	■		■	47
7 Mounting plate VN...-BP-NRH		-		■			■	46
- Suction cup holder ESH		■			■		■	esh
- suction cup ESS		■			■		■	ess

# Vacuum generators VN

Type codes

VN – 05 – H – T2 – PQ1 – VQ1 – RQ1

Type	
VN	Vacuum generator

Nominal size of laval nozzle [mm]	
05	0.45
07	0.7
10	0.95
14	1.4
20	2.0
30	3.0

Ejector characteristic	
H	High vacuum/Standard
L	High suction rate/Standard
M	High vacuum/Inline
N	High suction rate/Inline

Housing type	
I2	Inline, grid dimensions 10 mm
I3	Inline, grid dimensions 13 mm
T2	T-type, grid dimensions 10 mm
T3	T-type, grid dimensions 14 mm
T4	T-type, grid dimensions 18 mm
T6	T-type, grid dimensions 24 mm

Pneumatic connection 1	
PQ1	Push-in fitting QS-4
PQ2	Push-in fitting QS-6
PQ4	Push-in fitting QS-10
PI2	Female thread M5
PI4	Female thread G $\frac{1}{8}$
PI5	Female thread G $\frac{1}{4}$

Vacuum connection	
VQ1	Push-in fitting QS-4
VQ2	Push-in fitting QS-6
VQ3	Push-in fitting QS-8
VQ5	Push-in fitting QS-12
VI2	Female thread M5
VI4	Female thread G $\frac{1}{8}$
VI5	Female thread G $\frac{1}{4}$
VI6	Female thread G $\frac{3}{8}$
VA4	Male thread G $\frac{1}{8}$
VA5	Male thread G $\frac{1}{4}$
VT1	Push-in sleeve $\varnothing$ 4 mm
VT2	Push-in sleeve $\varnothing$ 6 mm

Pneumatic connection 3	
RQ1	Push-in fitting QS-4
RQ2	Push-in fitting QS-6
RQ3	Push-in fitting QS-8
RI2	Female thread M5
RI4	Female thread G $\frac{1}{8}$
RI5	Female thread G $\frac{1}{4}$
RO1	Silencer UO, minimal resistance
RO2	Silencer UOM, minimal resistance

 Note  
Possible combinations can be found in the ordering data.

# Vacuum generators VN

Technical data

FESTO

Function  
Standard

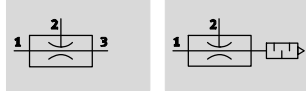

Inline

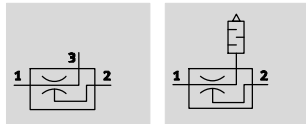

- Temperature range  
0 ... +60 °C
- Operating pressure  
1 ... 8 bar

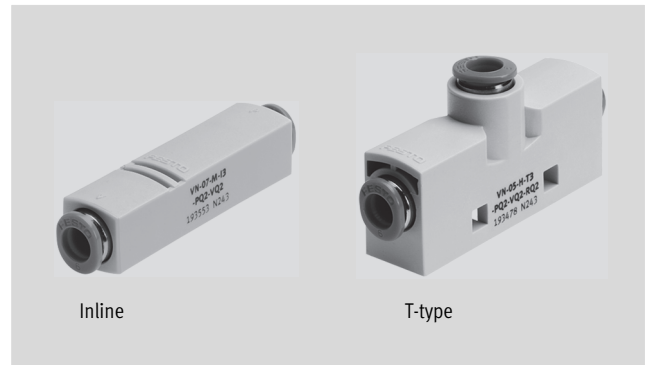

General technical data – Standard											
Design		T-type									
Type		VN-05		VN-07		VN-10		VN-14	VN-20	VN-30	
Grid dimension	[mm]	10	14	10	14	14	18	18	24	24	
Nominal size of laval nozzle	[mm]	0.45		0.7		0.95		1.4	2.0	3.0	
Ejector characteristic		High vacuum H									
		High suction rate L			–	High suction rate L					
Pneumatic connection 1	Push-in fitting	QS-4	QS-6	QS-4	QS-6	QS-6	QS-6	QS-6	QS-10	QS-10	
	Female thread	M5	G1/8	M5	G1/8	G1/8	–	G1/8	G1/4	G1/4	
Vacuum connection	Push-in fitting	QS-4	QS-6	QS-4	QS-6	QS-6	QS-8	QS-8	QS-12	QS-12	
	Male thread	–	G1/8	–	G1/8	G1/8	G1/4	G1/4	G1/4	G1/4	
	Female thread	M5	G1/8	M5	G1/8	G1/8	–	G1/4	G3/8	G3/8	
Pneumatic connection 3	Push-in fitting	QS-4	QS-6	QS-4	QS-6	QS-6	QS-8	QS-8	–	–	
	Female thread	M5	G1/8	M5	G1/8	G1/8	–	G1/4	–	–	
	Silencer	min. resis.	min. resis.	min. resis.	min. resis.	min. resis.	min. resis.	min. resis.	min. resis.	min. resis.	
Type of mounting (max. tightening torque)		Via through-holes (0.5 Nm)							Via through-holes (0.8 Nm)		
		Via accessories									
Assembly position		Any									

General technical data – Inline										
Design		T-type				Inline				
Type		VN-05		VN-07		VN-05		VN-07		VN-10
Grid dimension	[mm]	10	14	10	14	10	13	10	13	13
Nominal size of laval nozzle	[mm]	0.45		0.7		0.45		0.7		0.95
Ejector characteristic		High vacuum M								
		–	High suction rate N	–	–	High suction rate N	–	–	–	–
Pneumatic connection 1	Push-in fitting	QS-4	QS-6	QS-4	QS-6	QS-4	QS-6	QS-4	QS-6	QS-6
	Female thread	M5	G1/8	M5	G1/8	–	–	–	–	–
Vacuum connection	Push-in fitting	QS-4	QS-6	QS-4	QS-6	QS-4	QS-6	QS-4	QS-6	QS-6
	Female thread	M5	G1/8	M5	G1/8	–	–	–	–	–
	Push-in sleeve	–	–	–	–	4	6	4	6	–
Pneumatic connection 3	Push-in fitting	QS-4	QS-6	QS-4	QS-6	Non-ducted				
	Female thread	M5	G1/8	M5	G1/8					
	Silencer	min. resis.	min. resis.	min. resis.	min. resis.					
Type of mounting (max. tightening torque)		Via through-holes (0.5 Nm)				Inline installation				
		Via accessories								
Assembly position		Any								

Note: This product conforms to ISO 1179-1 and to ISO 228-1

# Vacuum generators VN

Technical data

Operating and environmental conditions		
Operating pressure	[bar]	1 ... 8
Nominal operating pressure	[bar]	6
Operating medium		Compressed air in accordance with ISO 8573-1:2010 [7:4:4]
Note on operating/pilot medium		Operation with lubricated medium not possible
Ambient temperature	[°C]	0 ... +60
Temperature of medium	[°C]	0 ... +60
Corrosion resistance class CRC <sup>1)</sup>		1 (with push-in fitting)
		2 (without push-in fitting; exception: VN-...-T3-...-R01 → CRC 1)

- 1) Corrosion resistance class CRC 1 to Festo standard FN 940070  
 Low corrosion stress. For dry indoor applications or transport and storage protection. Also applies to parts behind covers, in the non-visible interior area, and parts which are covered in the application (e.g. drive trunnions).  
 Corrosion resistance class CRC 2 to Festo standard FN 940070  
 Moderate corrosion stress. Indoor applications in which condensation may occur. External visible parts with primarily decorative requirements for the surface and which are in direct contact with the ambient atmosphere typical for industrial applications.

Performance data – High vacuum										
Ejector characteristic		Standard H						Inline M		
Nominal size of laval nozzle	[mm]	0.45	0.7	0.95	1.4	2.0	3.0	0.45	0.7	0.95
Max. vacuum	[%]	88	88	89	88	92	93	86	86	86
Operating pressure for max. vacuum	[bar]	4.5	4.7	4.5	5.0	3.5	3.7	6.0	5.8	5.8
Max. suction rate with respect to atmosphere	[l/min]	6.2	16	25	51.6	98	186	6.1	13.5	28
Operating pressure for max. suction rate	[bar]	2.1	2.1	3.1	5.1	2.0	3.0	6.3	7.0	5.0
Air supply time at nominal operating pressure 6 bar (for 1 l volume) <sup>1)</sup>	[s]	4.8	1.9	1.1	0.5	0.2	0.1	4.7	2.1	0.96
Noise level at nominal operating pressure 6 bar	[dB (A)]	53	64	74 (R01) 71 (R02)	69	63	78	53	59	–

- 1) Duration for vacuum purging down to a residual vacuum of –0.05 bar after switching off the operating pressure.

Performance data – High suction rate										
Ejector characteristic		Standard L						Inline N		
Nominal size of laval nozzle	[mm]	0.45	0.7	0.95	1.4	2.0	3.0	0.45		
Max. suction rate with respect to atmosphere	[l/min]	15.7	38.8	62.7	90.0	188.0	339.0	12.0		
Operating pressure for max. suction rate	[bar]	5.0	6.2	4.0	8.0	3.0	6.0	6.0		
Air supply time at nominal operating pressure 6 bar (for 1 l volume) <sup>1)</sup>	[s]	1.7	0.5	0.46	0.25	0.15	0.1	1.57		
Noise level at nominal operating pressure 6 bar	[dB (A)]	53	66	73 (R01) 72 (R02)	77	60	70	48		

- 1) Duration for vacuum purging down to a residual vacuum of –0.05 bar after switching off the operating pressure.

# Vacuum generators VN

Technical data

## Materials

Sectional view

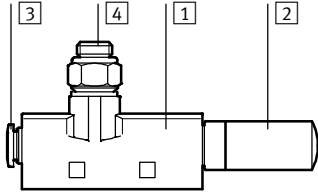

Vacuum generator VN-05/07/10/14			
1	Housing	POM-reinforced	
2	Silencer	RO1	PE
		RO2	Die-cast aluminium, POM, PU foam
3	Push-in fitting	Nickel plated brass	
4	Connecting thread	VA	Wrought aluminium alloy
		PI, VI, RI	Anodised wrought aluminium alloy
		T3-RO1	Nickel plated brass
-	Jet nozzle	Wrought aluminium alloy	
-	Receiver nozzle	POM	
-	Seals	NBR	
Note on materials			RoHS-compliant
			Free of copper and PTFE
		RO2	Contains paint-wetting impairment substances

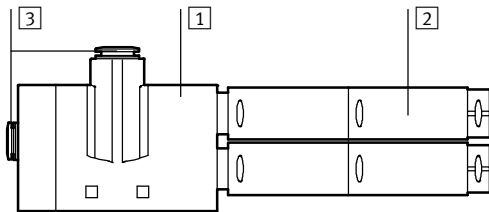

Vacuum generator VN-20/30			
1	Housing	POM-reinforced	
2	Silencer	Die-cast aluminium, POM, PU foam	
3	Push-in fitting	Nickel plated brass	
-	Connecting thread	VA	Wrought aluminium alloy
		PI, VI	Anodised wrought aluminium alloy
-	Jet nozzle	Wrought aluminium alloy	
-	Receiver nozzle	POM	
-	Seals	NBR	
Note on materials			RoHS-compliant
			Free of copper and PTFE
			Contains paint-wetting impairment substances

# Vacuum generators VN

Technical data

FESTO

## Vacuum $p_u$ as a function of operating pressure $p_1$

High vacuum

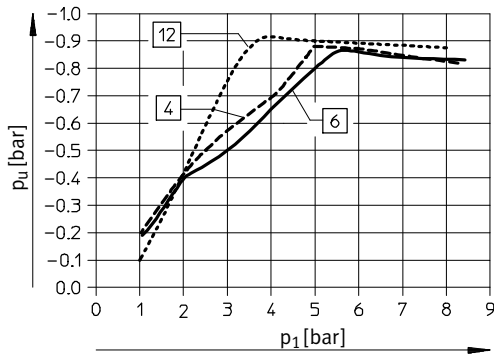
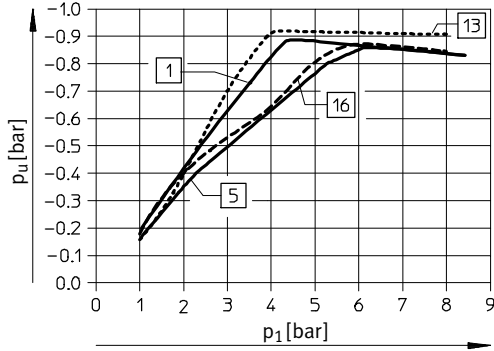

High suction rate

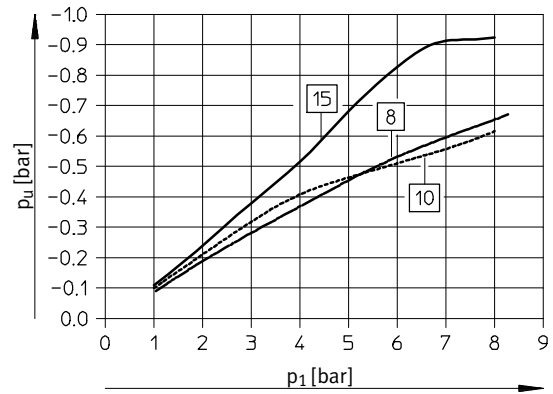
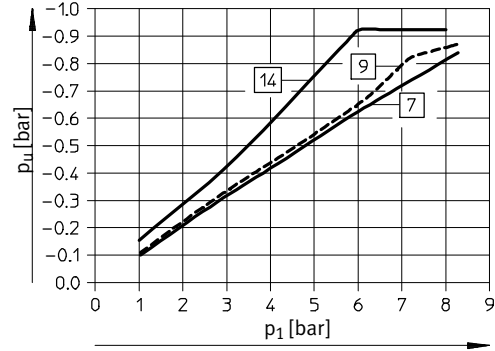

Standard:

- 1 VN-05-H-...
- VN-07-H-...
- VN-10-H-...
- 4 VN-14-H-...
- 12 VN-20-H-...
- 13 VN-30-H-...

Inline:

- 5 VN-05-M-...
- 6 VN-07-M-...
- 16 VN-10-M-...

Standard:

- 7 VN-05-L-...
- 8 VN-07-L-...
- 9 VN-10-L-...
- 10 VN-14-L-...
- 14 VN-20-L-...
- 15 VN-30-L-...

Inline:

- 8 VN-05-N-...



# Vacuum generators VN

Technical data

FESTO

## Evacuation time $t$ as a function of vacuum $p_u$ for 1 l volume at 6 bar operating pressure

High vacuum

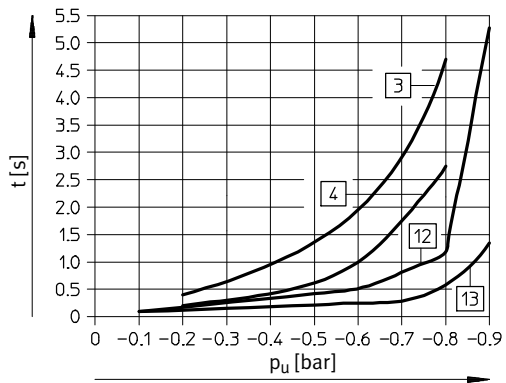
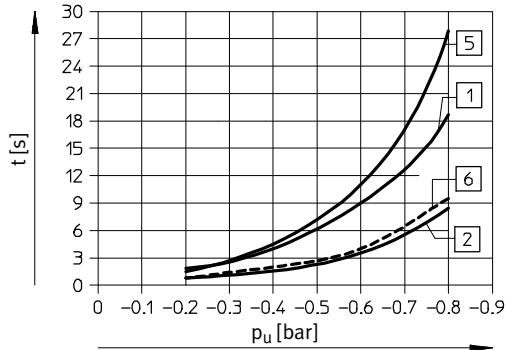

Standard:

- 1 VN-05-H...
- 2 VN-07-H...
- 3 VN-10-H...
- 4 VN-14-H...
- 12 VN-20-H...
- 13 VN-30-H...

Inline:

- 5 VN-05-M...
- 6 VN-07-M...
- 3 VN-10-M...

High suction rate

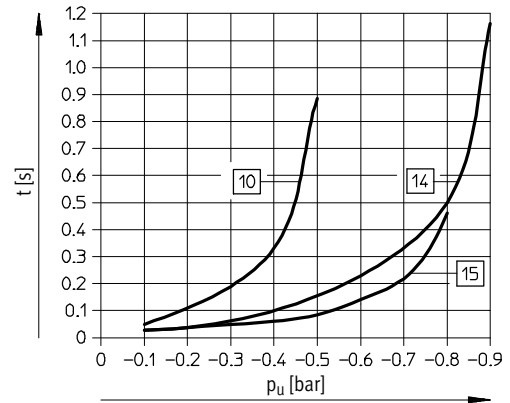
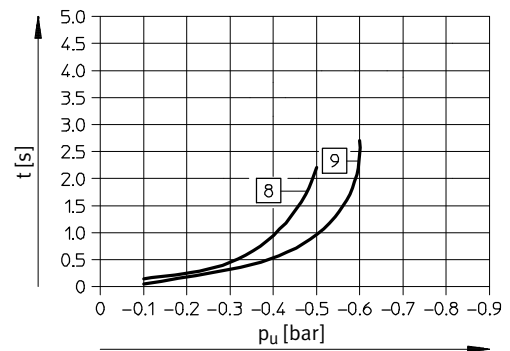
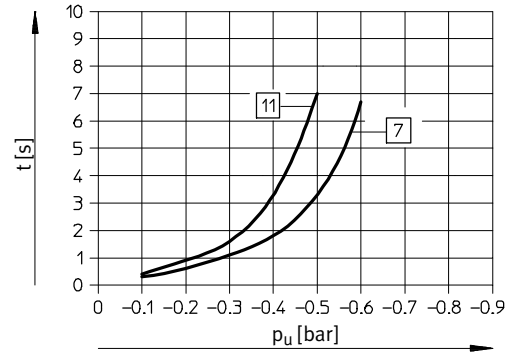

Standard:

- 7 VN-05-L...
- 8 VN-07-L...
- 9 VN-10-L...
- 10 VN-14-L...
- 14 VN-20-L...
- 15 VN-30-L...

Inline:

- 11 VN-05-N...

# Vacuum generators VN

Technical data

FESTO

## Suction rate $q_{ns}$ (with respect to atmosphere) as a function of operating pressure $p_1$

High vacuum

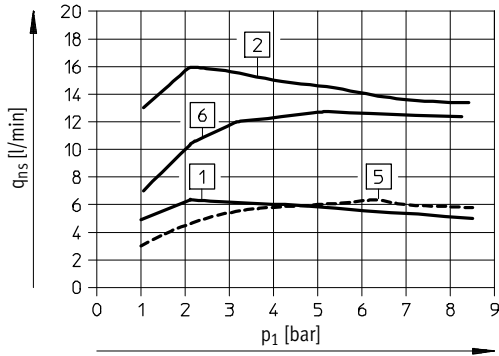

High suction rate

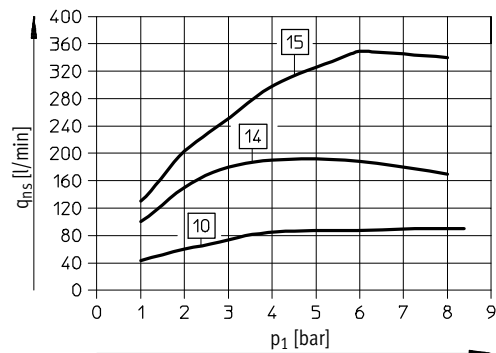
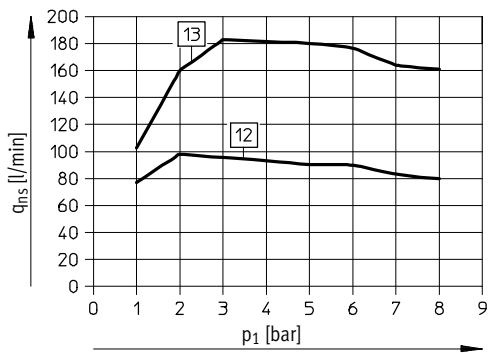
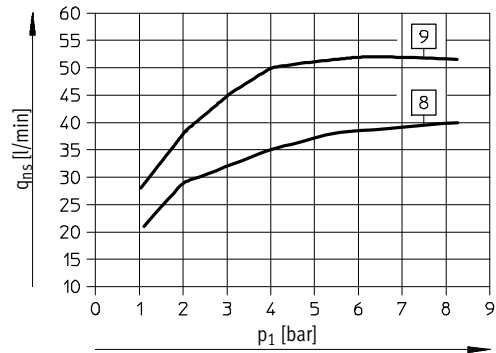
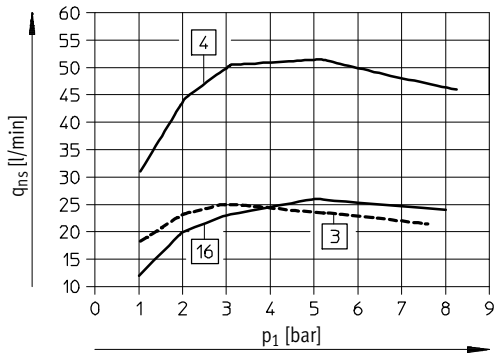
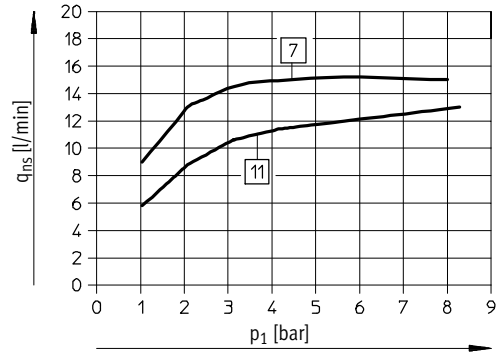

Standard:

- 1 VN-05-H...
- 2 VN-07-H...
- 3 VN-10-H...
- 4 VN-14-H...
- 12 VN-20-H...
- 13 VN-30-H...

Inline:

- 5 VN-05-M...
- 6 VN-07-M...
- 16 VN-10-M...

Standard:

- 7 VN-05-L...
- 8 VN-07-L...
- 9 VN-10-L...
- 10 VN-14-L...
- 14 VN-20-L...
- 15 VN-30-L...

Inline:

- 11 VN-05-N...

# Vacuum generators VN

Technical data

FESTO

## Air consumption $q_n$ as a function of operating pressure $p_1$

High vacuum/high suction rate

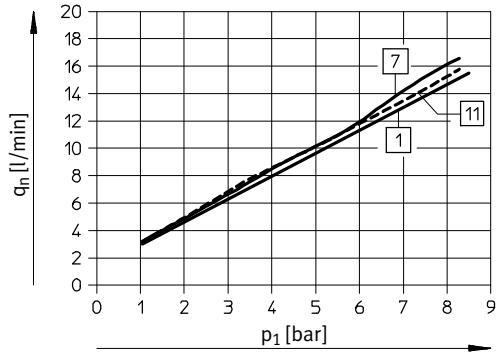

Standard:

- 1 VN-05-H...
- 7 VN-05-L...

Inline:

- 1 VN-05-M...
- 11 VN-05-N...

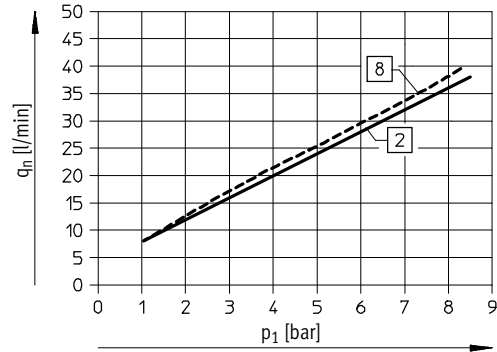

Standard:

- 2 VN-07-H...
- 8 VN-07-L...

Inline:

- 2 VN-07-M...

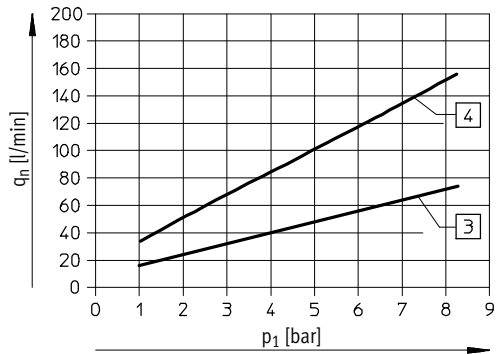

Standard:

- 3 VN-10-H...
- VN-10-L...
- 4 VN-14-H...
- VN-14-L...

Inline:

- 3 VN-10-M...

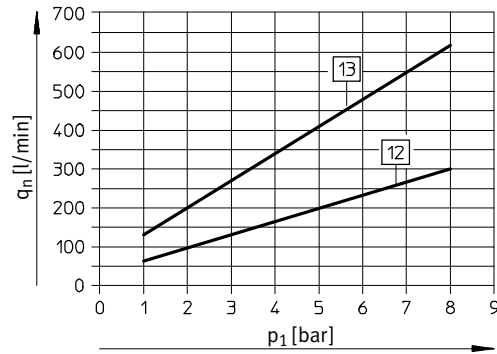

Standard:

- 12 VN-20-H...
- VN-20-L...
- 13 VN-30-H...
- VN-30-L...

# Vacuum generators VN

Technical data

FESTO

## Dimensions – T-type/Standard, VN-05/07/10/14

Download CAD data → [www.festo.com](http://www.festo.com)

VN-...-T...-PQ...-VQ...-RQ...

VN-...-T...-PQ...-VQ...-RO...

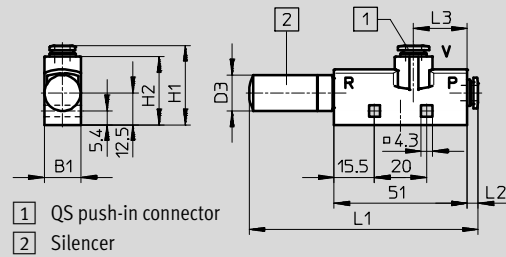
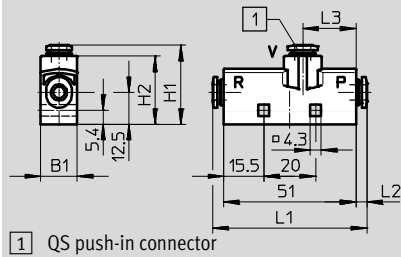

VN-...-T...-PQ...-VA...-RQ...

VN-...-T...-PQ...-VA...-RO...

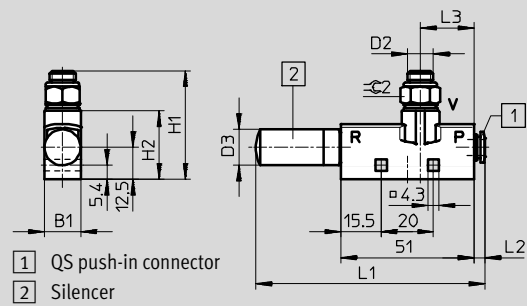
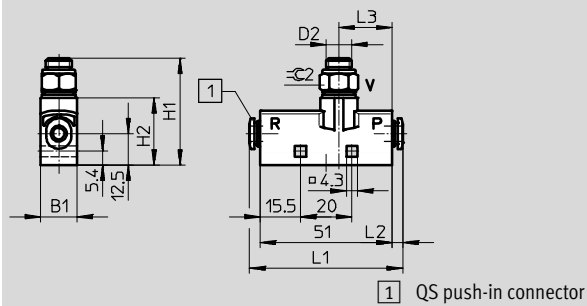

VN-...-T...-PI...-VI...-RI...

VN-...-T...-PI...-VI...-RO...

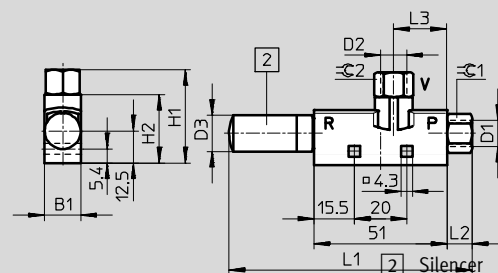
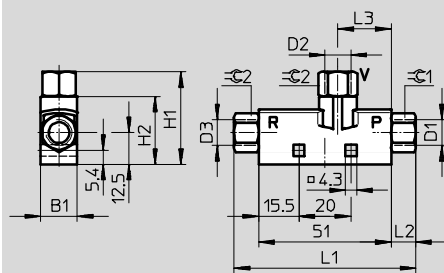

Type	B1	Connections			H1	H2	L1	L2	L3	∅1	∅2		
		P D1	V D2	R D3									
VN-...-T2-PQ1-VQ1-RQ1	10	QS-4	QS-4	QS-4	31.3	27.7	58.2	3.6	24.3	-	-		
VN-...-T2-PQ1-VQ1-RO1				9.8 <sup>1)</sup>			86.8						
VN-...-T2-PI2-VI2-RI2		M5	M5	M5			61						
VN-...-T2-PI2-VI2-RO1				9.8 <sup>1)</sup>			88.2	5				9	9
VN-...-T3-PQ2-VQ2-RQ2	14	QS-6	QS-6	QS-6	30.4	26.2	59.4	4.2	25.5	-	-		
VN-...-T3-PQ2-VQ2-RO1				13.8 <sup>1)</sup>			97.6						
VN-...-T3-PQ2-VA4-RQ2			G <sup>1</sup> / <sub>8</sub>	G <sup>1</sup> / <sub>8</sub>			QS-6	59.4					
VN-...-T3-PQ2-VA4-RO1							13.8 <sup>1)</sup>	97.6					
VN-...-T3-PI4-VI4-RI4		G <sup>1</sup> / <sub>8</sub>	G <sup>1</sup> / <sub>8</sub>	G <sup>1</sup> / <sub>8</sub>			70	9.5				13	13
VN-...-T3-PI4-VI4-RO1				13.8 <sup>1)</sup>			102.9						
VN-...-T4-PQ2-VQ3-RQ3	18	QS-6	QS-8	QS-8	35.9	30.7	63.8	4.2	25.5	-	-		
VN-...-T4-PQ2-VQ3-RO2				17.8 <sup>1)</sup>			125.5						
VN-...-T4-PQ2-VA5-RQ3			G <sup>1</sup> / <sub>4</sub>	G <sup>1</sup> / <sub>4</sub>			QS-8	63.8					
VN-...-T4-PQ2-VA5-RO2							17.8 <sup>1)</sup>	125.5					
VN-...-T4-PI4-VI5-RI5		G <sup>1</sup> / <sub>8</sub>	G <sup>1</sup> / <sub>4</sub>	G <sup>1</sup> / <sub>4</sub>			81.4	9.5				13	17
VN-...-T4-PI4-VI5-RO2				17.8 <sup>1)</sup>			128.8						

1) ∅ Silencer

∅ - Note: This product conforms to ISO 1179-1 and to ISO 228-1

# Vacuum generators VN

Technical data

FESTO

## Dimensions – T-type/Standard, VN-10

Download CAD data → [www.festo.com](http://www.festo.com)

VN-10-L-T3-PI4-VA4-R01

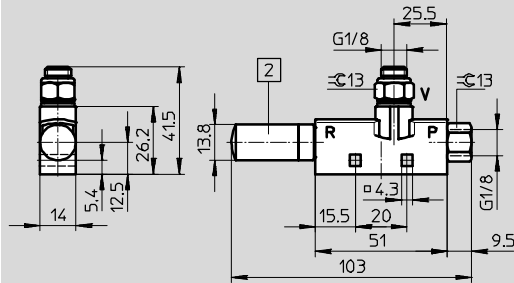

2 Silencer

Note: This product conforms to ISO 1179-1 and to ISO 228-1

## Dimensions – T-type/Standard, VN-20/30

Download CAD data → [www.festo.com](http://www.festo.com)

VN-...-T6-PQ4-VQ5-R02

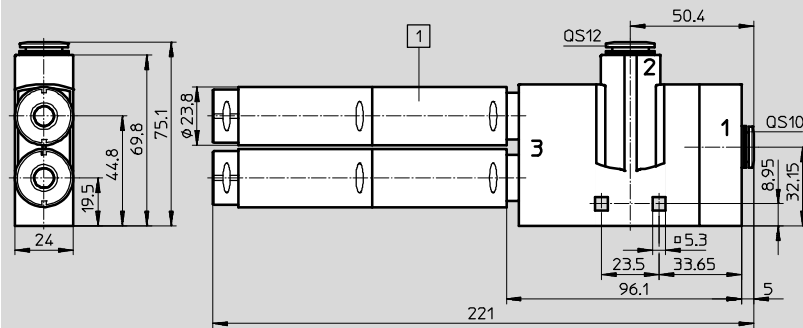

1 Silencer

VN-...-T6-PQ4-VA5-R02

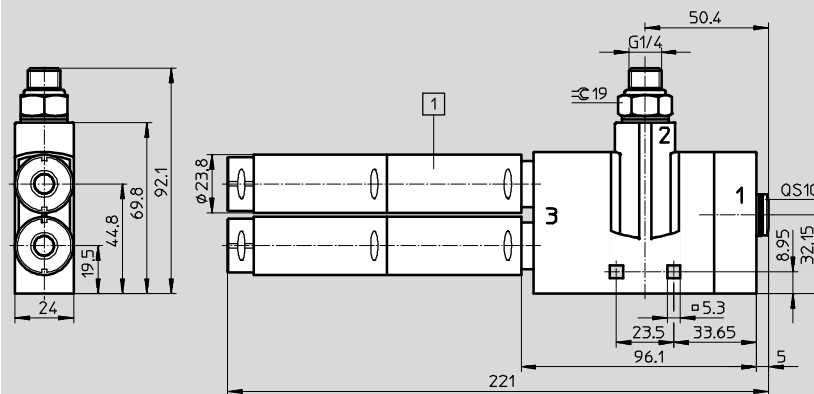

1 Silencer

Note: This product conforms to ISO 1179-1 and to ISO 228-1

VN-...-T6-PI5-VI6-R02

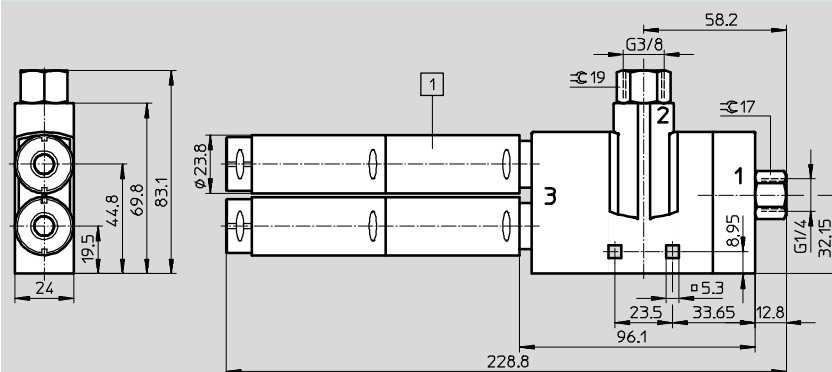

1 Silencer

Note: This product conforms to ISO 1179-1 and to ISO 228-1

# Vacuum generators VN

Technical data

FESTO

## Dimensions – T-type/Inline, VN-05/07

Download CAD data → [www.festo.com](http://www.festo.com)

VN-...-T...-PQ...-VQ...-RQ...

VN-...-T...-PQ...-VQ...-R01

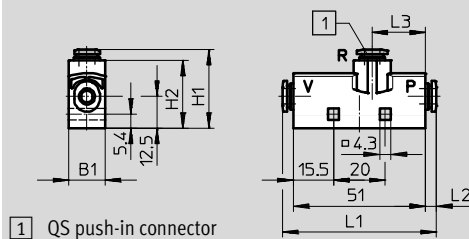

1 QS push-in connector

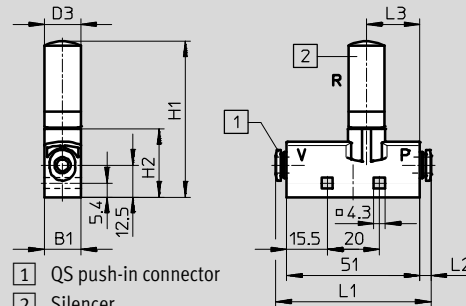

1 QS push-in connector  
2 Silencer

VN-...-T...-PI...-VI...-RI...

VN-...-T...-PI...-VI...-R01

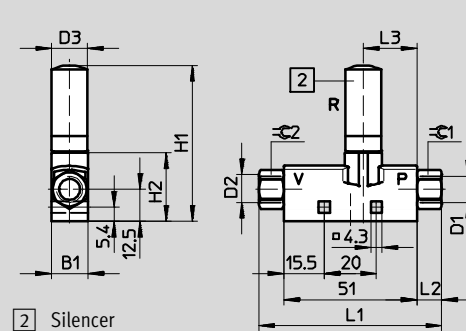
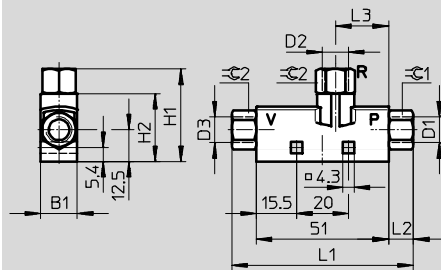

2 Silencer

Type	B1	Connections			H1	H2	L1	L2	L3	C1	C2
		P D1	V D2	R D3							
VN-...-T2-PQ1-VQ1-RQ1	10	QS-4	QS-4	QS-4	31.3	27.7	58.2	3.6	24.3	-	-
VN-...-T2-PQ1-VQ1-R01				9.8 <sup>1)</sup>	59.9						
VN-...-T2-PI2-VI2-RI2		M5	M5	M5	32.7		61	5		9	9
VN-...-T2-PI2-VI2-R01				9.8 <sup>1)</sup>	59.9						
VN-...-T3-PQ2-VQ2-RQ2	14	QS-6	QS-6	QS-6	30.4	26.2	59.4	4.2	25.5	-	-
VN-...-T3-PQ2-VQ2-R01				13.8 <sup>1)</sup>	68.6						
VN-...-T3-PI4-VI4-RI4		G <sup>1</sup> / <sub>8</sub>	G <sup>1</sup> / <sub>8</sub>	G <sup>1</sup> / <sub>8</sub>	35.7		70	9.5		13	13
VN-...-T3-PI4-VI4-R01				13.8 <sup>1)</sup>	68.6						

1) ∅ Silencer

∅ - Note: This product conforms to ISO 1179-1 and to ISO 228-1

## Dimensions – Inline, VN-05/07/10

Download CAD data → [www.festo.com](http://www.festo.com)

VN-05/07-...-I...-PQ...-VQ...

VN-10-M-I3-PQ2-VQ2

VN-05/07-...-I...-PQ...-VT...

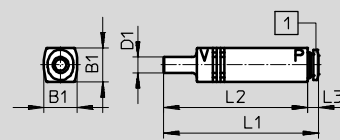
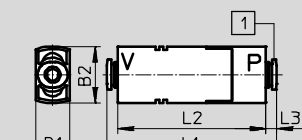
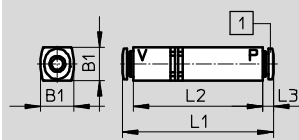

1 QS push-in connector

Type	B1	B2	Connections		D1 ∅	L1	L2	L3
			P	V				
VN-05/07-...-I2-PQ1-VQ1	10	-	QS-4	QS4	-	57.4	50.2	3.6
VN-05/07-...-I2-PQ1-VT1				-	4	61.6	58	
VN-05/07-...-I3-PQ2-VQ2	13	-	QS-6	QS6	-	58.6	50.2	4.2
VN-10-M-I3-PQ2-VQ2		22				66.1	57.7	
VN-05/07-...-I3-PQ2-VT2		-				60.2	56	

# Vacuum generators VN

Technical data

FESTO

## ★ Core product range

Ordering data and weights – Standard							
T-type							
Housing width [mm]	Nominal size of laval nozzle [mm]	Weight [g]	High vacuum H		Weight [g]	High suction rate L	
			Part No.	Type		Part No.	Type
With push-in fitting							
14	0.95	22	★ 193480	VN-10-H-T3-PQ2-VQ2-RQ2	–	–	–
18	1.4	–	–	–	27	★ 193565	VN-14-L-T4-PQ2-VQ3-RQ3
With female thread							
14	0.95	22	★ 193500	VN-10-H-T3-PI4-VI4-RI4	–	–	–
18	1.4	36	★ 193502	VN-14-H-T4-PI4-VI5-RI5	–	–	–

Ordering data and weights – Inline							
Inline							
Housing width [mm]	Nominal size of laval nozzle [mm]	Weight [g]	High vacuum M		Weight [g]	High suction rate N	
			Part No.	Type		Part No.	Type
With push-in fitting							
13	0.7	16	★ 193553	VN-07-M-I3-PQ2-VQ2	–	–	–
With push-in fitting and push-in sleeve							
13	0.7	12	★ 193556	VN-07-M-I3-PQ2-VT2	–	–	–

Ordering data and weights – Standard							
T-type							
Housing width [mm]	Nominal size of laval nozzle [mm]	Weight [g]	High vacuum H		Weight [g]	High suction rate L	
			Part No.	Type		Part No.	Type
With push-in fitting							
10	0.45	15	526100	VN-05-H-T2-PQ1-VQ1-RQ1	15	526114	VN-05-L-T2-PQ1-VQ1-RQ1
	0.7	15	526101	VN-07-H-T2-PQ1-VQ1-RQ1	–	–	–
14	0.45	22	193478	VN-05-H-T3-PQ2-VQ2-RQ2	22	193561	VN-05-L-T3-PQ2-VQ2-RQ2
	0.7	22	193479	VN-07-H-T3-PQ2-VQ2-RQ2	22	193562	VN-07-L-T3-PQ2-VQ2-RQ2
	0.95	–	–	–	22	193563	VN-10-L-T3-PQ2-VQ2-RQ2
18	0.95	27	526147	VN-10-H-T4-PQ2-VQ3-RQ3	27	526157	VN-10-L-T4-PQ2-VQ3-RQ3
	1.4	27	193482	VN-14-H-T4-PQ2-VQ3-RQ3	–	–	–
With push-in fitting and silencer							
10	0.45	15	193569	VN-05-H-T2-PQ1-VQ1-R01	15	193595	VN-05-L-T2-PQ1-VQ1-R01
	0.7	15	193570	VN-07-H-T2-PQ1-VQ1-R01	–	–	–
14	0.45	24	193488	VN-05-H-T3-PQ2-VQ2-R01	24	193571	VN-05-L-T3-PQ2-VQ2-R01
	0.7	24	193489	VN-07-H-T3-PQ2-VQ2-R01	24	193572	VN-07-L-T3-PQ2-VQ2-R01
	0.95	24	193490	VN-10-H-T3-PQ2-VQ2-R01	24	193573	VN-10-L-T3-PQ2-VQ2-R01
18	0.95	36	549251	VN-10-H-T4-PQ2-VQ3-R02	36	549253	VN-10-L-T4-PQ2-VQ3-R02
	1.4	36	547707	VN-14-H-T4-PQ2-VQ3-R02	36	547710	VN-14-L-T4-PQ2-VQ3-R02
24	2.0	182	193495	VN-20-H-T6-PQ4-VQ5-R02	182	193578	VN-20-L-T6-PQ4-VQ5-R02
	3.0	182	193497	VN-30-H-T6-PQ4-VQ5-R02	–	–	–

Festo core product range

- ★ Ready for dispatch from the Festo factory in 24 hours
- ★ Ready for dispatch in 5 days maximum from stock

# Vacuum generators VN

FESTO

Technical data

Ordering data and weights – Standard							
T-type							
Housing width [mm]	Nominal size of laval nozzle [mm]	Weight [g]	High vacuum H		Weight [g]	High suction rate L	
			Part No.	Type		Part No.	Type
With push-in fitting, vacuum connection with male thread							
14	0.45	24	193516	VN-05-H-T3-PQ2-VA4-RQ2	24	193599	VN-05-L-T3-PQ2-VA4-RQ2
	0.7	24	193517	VN-07-H-T3-PQ2-VA4-RQ2	24	193600	VN-07-L-T3-PQ2-VA4-RQ2
	0.95	24	193518	VN-10-H-T3-PQ2-VA4-RQ2	24	193601	VN-10-L-T3-PQ2-VA4-RQ2
18	0.95	33	526153	VN-10-H-T4-PQ2-VA5-RQ3	33	526163	VN-10-L-T4-PQ2-VA5-RQ3
	1.4	33	193520	VN-14-H-T4-PQ2-VA5-RQ3	33	193603	VN-14-L-T4-PQ2-VA5-RQ3
With push-in fitting, vacuum connection with male thread and silencer							
14	0.45	26	193526	VN-05-H-T3-PQ2-VA4-R01	26	193609	VN-05-L-T3-PQ2-VA4-R01
	0.7	26	193527	VN-07-H-T3-PQ2-VA4-R01	26	193610	VN-07-L-T3-PQ2-VA4-R01
	0.95	26	193528	VN-10-H-T3-PQ2-VA4-R01	26	193611	VN-10-L-T3-PQ2-VA4-R01
18	0.95	42	549252	VN-10-H-T4-PQ2-VA5-R02	42	549254	VN-10-L-T4-PQ2-VA5-R02
	1.4	42	547706	VN-14-H-T4-PQ2-VA5-R02	42	547709	VN-14-L-T4-PQ2-VA5-R02
24	2.0	189	526145	VN-20-H-T6-PQ4-VA5-R02	189	526135	VN-20-L-T6-PQ4-VA5-R02
	3.0	189	526146	VN-30-H-T6-PQ4-VA5-R02	189	526136	VN-30-L-T6-PQ4-VA5-R02
With female thread							
10	0.45	13	526102	VN-05-H-T2-PI2-VI2-RI2	13	526116	VN-05-L-T2-PI2-VI2-RI2
	0.7	13	526103	VN-07-H-T2-PI2-VI2-RI2	–	–	–
14	0.45	22	193498	VN-05-H-T3-PI4-VI4-RI4	22	193581	VN-05-L-T3-PI4-VI4-RI4
	0.7	22	193499	VN-07-H-T3-PI4-VI4-RI4	22	193582	VN-07-L-T3-PI4-VI4-RI4
	0.95	–	–	–	22	193583	VN-10-L-T3-PI4-VI4-RI4
18	1.4	–	–	–	36	193585	VN-14-L-T4-PI4-VI5-RI5
With female thread and silencer							
10	0.45	13	526104	VN-05-H-T2-PI2-VI2-R01	13	526118	VN-05-L-T2-PI2-VI2-R01
	0.7	13	526105	VN-07-H-T2-PI2-VI2-R01	–	–	–
14	0.45	24	193507	VN-05-H-T3-PI4-VI4-R01	24	193590	VN-05-L-T3-PI4-VI4-R01
	0.7	24	193508	VN-07-H-T3-PI4-VI4-R01	24	193591	VN-07-L-T3-PI4-VI4-R01
	0.95	24	193509	VN-10-H-T3-PI4-VI4-R01	24	193592	VN-10-L-T3-PI4-VI4-R01
18	1.4	40	547705	VN-14-H-T4-PI4-VI5-R02	40	547708	VN-14-L-T4-PI4-VI5-R02
24	2.0	183	526141	VN-20-H-T6-PI5-VI6-R02	183	526131	VN-20-L-T6-PI5-VI6-R02
	3.0	183	526142	VN-30-H-T6-PI5-VI6-R02	183	526132	VN-30-L-T6-PI5-VI6-R02
With female thread, vacuum connection with male thread and silencer							
14	0.95	–	–	–	26	543315	VN-10-L-T3-PI4-VA4-R01



# Vacuum generators VN

Technical data

FESTO

Ordering data and weights – Inline							
T-type							
Housing width [mm]	Nominal size of laval nozzle [mm]	Weight [g]	High vacuum M		Weight [g]	High suction rate N	
			Part No.	Type		Part No.	Type
With push-in fitting							
10	0.45	15	<b>526106</b>	<b>VN-05-M-T2-PQ1-VQ1-RQ1</b>	-	-	-
	0.7	15	<b>526107</b>	<b>VN-07-M-T2-PQ1-VQ1-RQ1</b>			
14	0.45	22	<b>193536</b>	<b>VN-05-M-T3-PQ2-VQ2-RQ2</b>	22	<b>193619</b>	<b>VN-05-N-T3-PQ2-VQ2-RQ2</b>
	0.7	22	<b>193537</b>	<b>VN-07-M-T3-PQ2-VQ2-RQ2</b>	-	-	-
With push-in fitting and silencer							
10	0.45	15	<b>526108</b>	<b>VN-05-M-T2-PQ1-VQ1-R01</b>	-	-	-
	0.7	15	<b>526109</b>	<b>VN-07-M-T2-PQ1-VQ1-R01</b>			
14	0.45	24	<b>193540</b>	<b>VN-05-M-T3-PQ2-VQ2-R01</b>	24	<b>193623</b>	<b>VN-05-N-T3-PQ2-VQ2-R01</b>
	0.7	24	<b>193541</b>	<b>VN-07-M-T3-PQ2-VQ2-R01</b>	-	-	-
With female thread							
10	0.45	13	<b>526110</b>	<b>VN-05-M-T2-PI2-VI2-RI2</b>	-	-	-
	0.7	13	<b>526111</b>	<b>VN-07-M-T2-PI2-VI2-RI2</b>			
14	0.45	22	<b>193544</b>	<b>VN-05-M-T3-PI4-VI4-RI4</b>	22	<b>193627</b>	<b>VN-05-N-T3-PI4-VI4-RI4</b>
	0.7	22	<b>193545</b>	<b>VN-07-M-T3-PI4-VI4-RI4</b>	-	-	-
With female thread and silencer							
10	0.45	13	<b>526112</b>	<b>VN-05-M-T2-PI2-VI2-R01</b>	-	-	-
	0.7	13	<b>526113</b>	<b>VN-07-M-T2-PI2-VI2-R01</b>			
14	0.45	24	<b>193548</b>	<b>VN-05-M-T3-PI4-VI4-R01</b>	24	<b>193631</b>	<b>VN-05-N-T3-PI4-VI4-R01</b>
	0.7	24	<b>193549</b>	<b>VN-07-M-T3-PI4-VI4-R01</b>	-	-	-

Ordering data and weights – Inline							
Inline							
Housing width [mm]	Nominal size of laval nozzle [mm]	Weight [g]	High vacuum M		Weight [g]	High suction rate N	
			Part No.	Type		Part No.	Type
With push-in fitting							
10	0.45	11	<b>193580</b>	<b>VN-05-M-I2-PQ1-VQ1</b>	-	-	-
	0.7	11	<b>193586</b>	<b>VN-07-M-I2-PQ1-VQ1</b>			
13	0.45	16	<b>193552</b>	<b>VN-05-M-I3-PQ2-VQ2</b>	16	<b>193635</b>	<b>VN-05-N-I3-PQ2-VQ2</b>
	0.95	23	<b>193554</b>	<b>VN-10-M-I3-PQ2-VQ2</b>	-	-	-
With push-in fitting and push-in sleeve							
10	0.45	8	<b>193587</b>	<b>VN-05-M-I2-PQ1-VT1</b>	-	-	-
	0.7	8	<b>193588</b>	<b>VN-07-M-I2-PQ1-VT1</b>			
13	0.45	12	<b>193555</b>	<b>VN-05-M-I3-PQ2-VT2</b>	12	<b>193637</b>	<b>VN-05-N-I3-PQ2-VT2</b>

# Vacuum generators VN-P, with integrated vacuum switch

Peripherals overview and type codes

## Peripherals overview

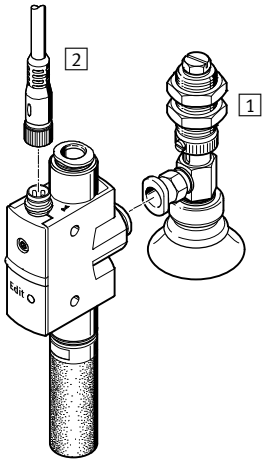

Mounting attachments and accessories	→ Page/Internet
1 Suction gripper ESG	esg
2 Plug socket with cable, 3-pin NEBU-M8	48
- Suction cup holder ESH	esh
- Suction cup ESS	ess

## Type codes

VN – 05 – H – T4 – PQ2 – VQ2 – O2 – P

### Type

VN	Vacuum generator
----	------------------

### Nominal size of laval nozzle [mm]

05	0.45
07	0.7
10	0.95

### Ejector characteristic

H	High vacuum/Standard
L	High suction rate/Standard

### Housing type

T4	T-type, grid dimensions 16 mm
----	-------------------------------

### Pneumatic connection 1

PQ2	Push-in fitting QS-6
-----	----------------------

### Vacuum connection

VQ2	Push-in fitting QS-6
-----	----------------------

### Switching function

O1	Threshold value with fixed hysteresis, 2 teach-in points, NO contact
O2	Threshold value with variable hysteresis, NO contact

### Electrical output

P	Switch output PNP
---	-------------------

# Vacuum generators VN-P, with integrated vacuum switch

Technical data

Function  
VN Standard

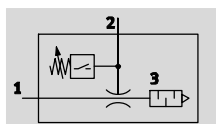

- - Temperature range  
0 ... +60 °C
- - Operating pressure  
1 ... 8 bar



- Threshold value comparator with fixed or variable hysteresis
- Teach-in setting option for threshold value and hysteresis

General technical data			
Design	T-type		
Type	VN-05	VN-07	VN-10
Grid dimension [mm]	16	16	16
Nominal size of laval nozzle [mm]	0.45	0.7	0.95
Ejector characteristic	High vacuum/Standard H High suction rate/Standard L		
Pneumatic connection 1	QS-6		
Vacuum connection	QS-6		
Pneumatic connection 3	Silencer, minimal resistance		
Measured variable	Relative pressure		
Measuring principle	Piezoresistive		
Pressure measuring range [bar]	-1 ... 0		
Type of mounting (max. tightening torque)	Via through-holes (0.6 Nm)		
Assembly position	Any <sup>1)</sup>		
Cleaning recommendation	Soap suds		
Product weight [g]	33	36	36

1) The collection of condensate in the sensor should be prevented.

Operating and environmental conditions	
Operating pressure [bar]	1 ... 8
Nominal operating pressure [bar]	6
Operating medium	Compressed air in accordance with ISO 8573-1:2010 [7:4:4]
Note on operating/pilot medium	Operation with lubricated medium not possible
Ambient temperature [°C]	0 ... +50
Temperature of medium [°C]	0 ... +60
Corrosion resistance class CRC <sup>1)</sup>	1
CE mark (see declaration of conformity)	To EU EMC Directive <sup>2)</sup>
Certification	RCM Mark

1) Corrosion resistance class CRC 1 to Festo standard FN 940070  
Low corrosion stress. For dry indoor applications or transport and storage protection. Also applies to parts behind covers, in the non-visible interior area, and parts which are covered in the application (e.g. drive trunnions).

2) For information about the applicability of the component see the manufacturer's EC declaration of conformity at: [www.festo.com/sp](http://www.festo.com/sp) → User documentation.  
If the component is subject to restrictions on usage in residential, office or commercial environments or small businesses, further measures to reduce the emitted interference may be necessary.

# Vacuum generators VN-P, with integrated vacuum switch

FESTO

Technical data

Performance data							
Ejector characteristic		High vacuum/Standard H			High suction rate/Standard L		
Nominal size of laval nozzle	[mm]	0.45	0.7	0.95	0.45	0.7	0.95
Max. vacuum	[%]	92	92	93	–	–	–
Operating pressure for max. vacuum	[bar]	4.9	4.4	3.5	–	–	–
Max. suction rate with respect to atmosphere	[l/min]	7.2	16.2	21.8	13.6	30.9	41.5
Operating pressure for max. suction rate	[bar]	3	3	3	5	4	5
Noise level at nominal operating pressure 6 bar	[dB (A)]	62	66	70	54	63	66

Electrical data		
Operating voltage range	[V DC]	15 ... 30
Residual ripple	[%]	10
Electrical connection		M8x1, 3-pin
Switch-on/switch-off times	[ms]	≤ 4
Switch output		PNP
Max. output current	[mA]	100
Residual current	[mA]	≤ 0.3
Voltage drop	[V]	≤ 1.5
Switching element function		NO contact
Setting options		Teach-In
Switching function		Threshold value comparator with fixed hysteresis Threshold value comparator with variable hysteresis
Threshold value setting range	[bar]	–1 ... 0
Accuracy	[% FS] <sup>1)</sup>	±1.5
Hysteresis	[% FS] <sup>1)</sup>	±2 (threshold value comparator with fixed hysteresis)
Long-term drift	[% FS] <sup>1)</sup>	Max. ±0.5
Temperature coefficient of switching point	[%/K]	0.05
Type of display/switching status display		LED
Inductive protective circuit		Adapted to MZ, MY, ME coils
Protection against short circuit		Pulsed
Protection against polarity reversal		For all electrical connections
Protection against overloading		Yes
Protection class		IP40 (to EN 60 529)

1) % FS = % of the measuring range final value (full scale)

## Electrical outputs<sup>1)</sup> Pin allocations

**1 switch output PNP**

Plug M8x1

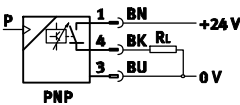

1 = +24 V  
3 = 0 V  
4 = Output A



1) Core colours indicated apply when using plug sockets with cable NEBU-M8, 3-pin. Technical data → Internet: nebu-m8\*3

# Vacuum generators VN-P, with integrated vacuum switch

Technical data

## Materials

General view

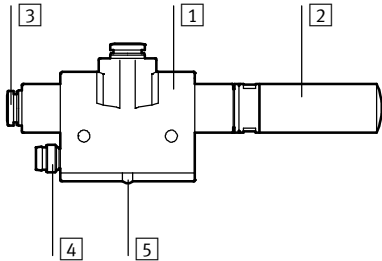

Vacuum generator		
1	Housing	POM-reinforced
2	Silencer	PE
3	Push-in fitting	Nickel plated brass
4	Plug housing	PA, nickel and chrome plated brass
5	Fibre optics	PC
-	Jet nozzle	Wrought aluminium alloy
-	Receiver nozzle	POM
-	Key pad	POM
-	Seals	NBR

## Vacuum $p_u$ as a function of operating pressure $p_1$

High vacuum/high suction rate

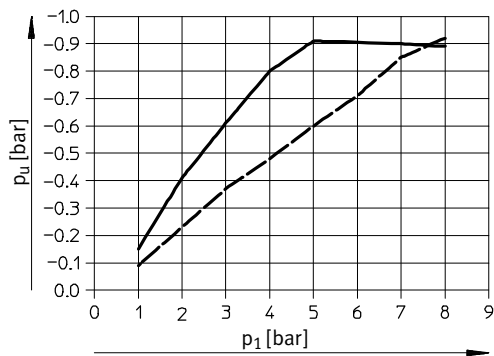

— VN-05-H  
- - - VN-05-L

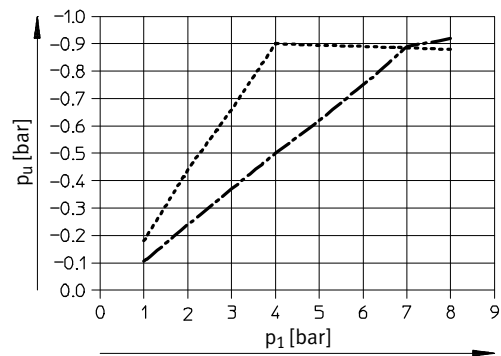

..... VN-07-H  
- - - VN-07-L

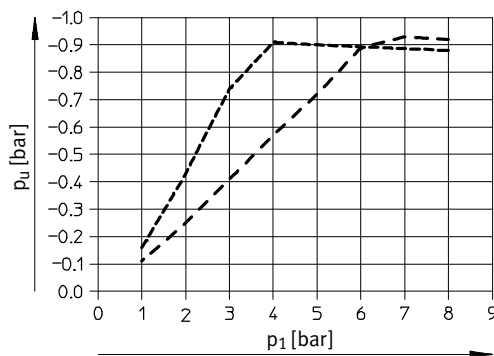

..... VN-10-H  
- - - VN-10-L

# Vacuum generators VN-P, with integrated vacuum switch

Technical data

## Evacuation time $t$ as a function of vacuum $p_u$ for 1 l volume at 6 bar operating pressure

High vacuum/high suction rate

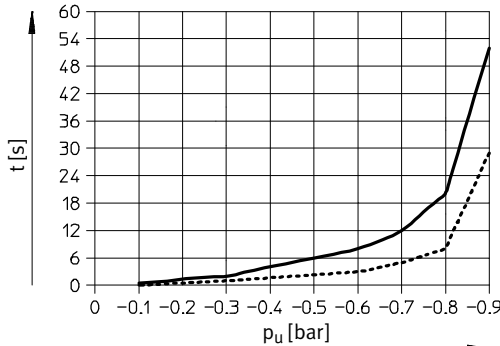

— VN-05-H  
 ..... VN-07-H

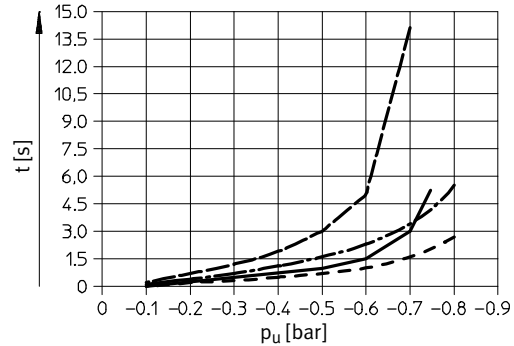

--- VN-05-L      — VN-10-H  
 - · - · - VN-07-L      - - - - - VN-10-L

## Suction rate $q_{ns}$ (with respect to atmosphere) as a function of operating pressure $p_1$

High vacuum/high suction rate

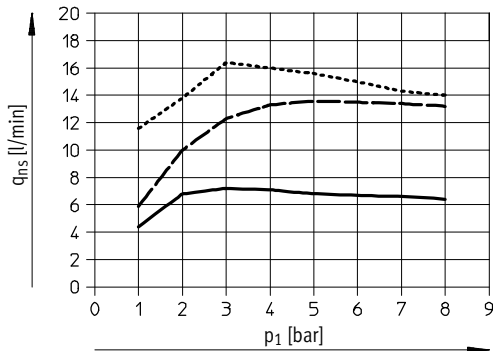

— VN-05-H  
 --- VN-05-L  
 ..... VN-07-H

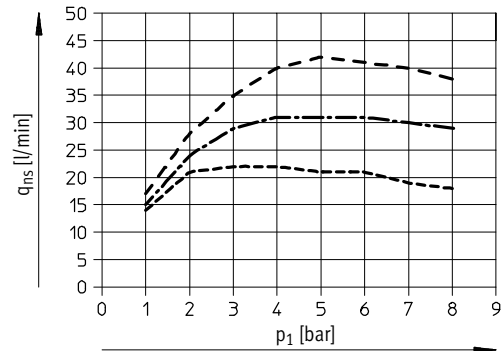

--- VN-07-L  
 - · - · - VN-10-H  
 - - - - - VN-10-L

## Air consumption $q_n$ as a function of operating pressure $p_1$

High vacuum/high suction rate

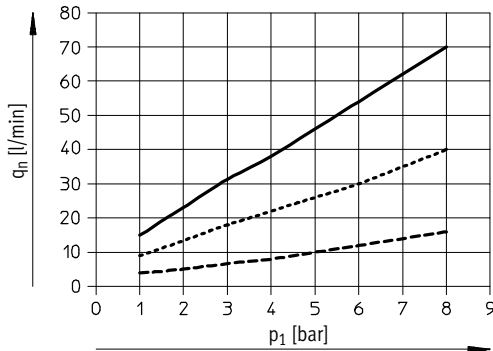

--- VN-05  
 ..... VN-07  
 — VN-10

# Vacuum generators VN-P, with integrated vacuum switch

Technical data

## Dimensions

Download CAD data → [www.festo.com](http://www.festo.com)

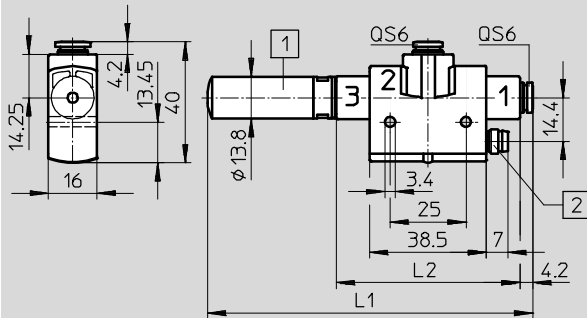

- 1 Silencer
- 2 Plug, M8x1, 3-pin

Type	L1	L2
VN-05	93.6	44.2
VN-07	107	60.5
VN-10		

## Ordering data

with push-in fitting and silencer

Nominal size of laval nozzle [mm]	Switching function		High vacuum/Standard H		High suction rate/Standard L	
	Threshold value with fixed hysteresis	Threshold value with variable hysteresis	Part No.	Type	Part No.	Type
0.45	■	–	536796	VN-05-H-T4-PQ2-VQ2-01-P	536798	VN-05-L-T4-PQ2-VQ2-01-P
	–	■	536797	VN-05-H-T4-PQ2-VQ2-02-P	536799	VN-05-L-T4-PQ2-VQ2-02-P
0.7	■	–	536800	VN-07-H-T4-PQ2-VQ2-01-P	536802	VN-07-L-T4-PQ2-VQ2-01-P
	–	■	536801	VN-07-H-T4-PQ2-VQ2-02-P	536803	VN-07-L-T4-PQ2-VQ2-02-P
0.95	■	–	536804	VN-10-H-T4-PQ2-VQ2-01-P	536806	VN-10-L-T4-PQ2-VQ2-01-P
	–	■	536805	VN-10-H-T4-PQ2-VQ2-02-P	536807	VN-10-L-T4-PQ2-VQ2-02-P

# Vacuum generators VN-A/M/B, with additional functions

Peripherals overview

Inline VN-05/07-...-A	T-type VN-05/07/10/14-...-A/M/B	VN-20/30-...-M
--------------------------	------------------------------------	----------------

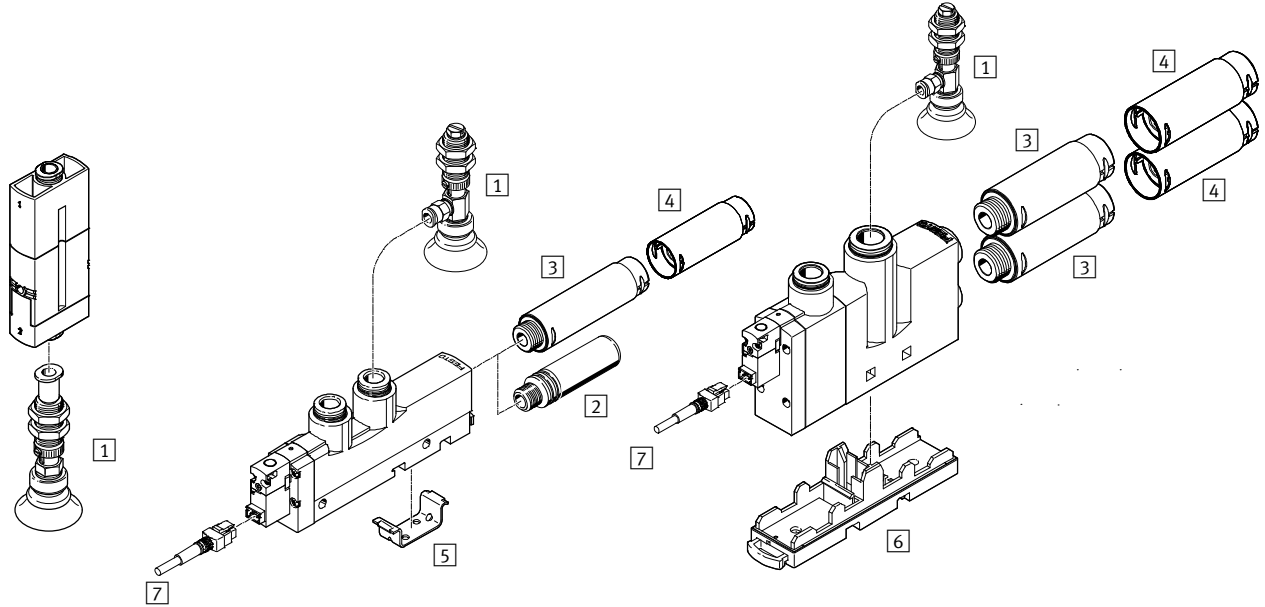

Mounting attachments and accessories							→ Page/Internet		
	Inline	T-type							
	VN-05/07	VN-05/07/10			VN-14			VN-20/30	
	A	A	M	B	A	M	B	M	
1 Suction gripper ESG	■	■	■	■	■	■	■	■	esg
2 Silencer UO	-	■	-	-	-	-	-	-	47
3 Silencer UOM	-	-	-	-	■	■	■	■	47
4 Silencer extension UOMS	-	-	-	-	■	■	■	■	47
5 Mounting bracket VN-T3/T4-BP	-	■	■	■	■	■	■	-	46
6 Mounting plate VN-T6-BP-NRH	-	-	-	-	-	-	-	■	46
7 Plug socket with cable, 2-pin NEBV	-	-	■	■	-	■	■	■	48
- Suction cup holder ESH	■	■	■	■	■	■	■	■	esh
- Suction cup ESS	■	■	■	■	■	■	■	■	ess



# Vacuum generators VN-A/M/B, with additional functions

Type codes

VN – 05 – H – T3 – PQ2 – VQ2 – R01 – M

**Type**

VN	Vacuum generator
----	------------------

**Nominal size of laval nozzle [mm]**

05	0.45
07	0.7
10	0.95
14	1.4
20	2.0
30	3.0

**Ejector characteristic**

H	High vacuum/Standard T-type
L	High suction rate/Standard T-type
M	High vacuum/Inline
N	High suction rate/Inline

**Housing type**

I3	Inline, grid dimension 14.5 mm
T3	T-type, grid dimension 14 mm
T4	T-type, grid dimension 18 mm
T6	T-type, grid dimension 24 mm

**Pneumatic connection 1**

PQ2	Push-in fitting QS-6
PQ3	Push-in fitting QS-8
PQ4	Push-in fitting QS-10
PI4	Female thread G $\frac{1}{8}$
PI5	Female thread G $\frac{1}{4}$

**Vacuum connection**

VQ2	Push-in fitting QS-6
VQ3	Push-in fitting QS-8
VQ5	Push-in fitting QS-12
VI4	Female thread G $\frac{1}{8}$
VI5	Female thread G $\frac{1}{4}$

**Pneumatic connection 3**

R01	Silencer UO, minimal resistance
R02	Silencer UOM, minimal resistance

**Integrated function**

A	Pneumatic ejector pulse
M	Electrical on-off valve
B	Electrical on-off valve and pneumatic ejector pulse

 Note  
Possible combinations can be found in the ordering data.

# Vacuum generators VN-A/M/B, with additional functions

FESTO

Technical data

Function

VN-A – Standard/Inline  
Pneumatic ejector pulse

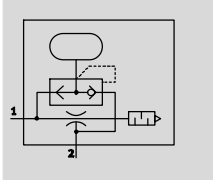

VN-A

- - Temperature range  
0 ... +60 °C

- - Operating pressure  
1 ... 8 bar

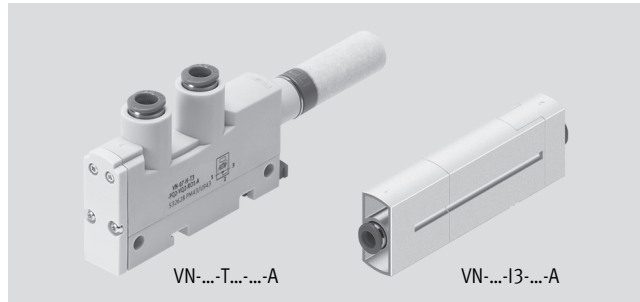

VN-M – Standard  
Electrical on-off valve

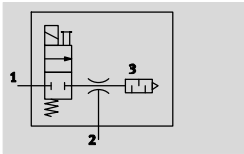

VN-M / VN-B

- - Temperature range  
0 ... +50 °C

- - Operating pressure  
2 ... 8 bar

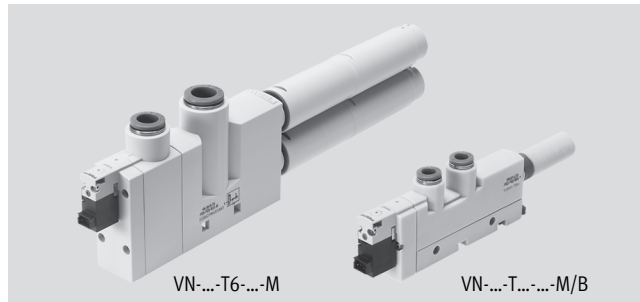

VN-B – Standard  
Electrical on-off valve,  
pneumatic ejector pulse

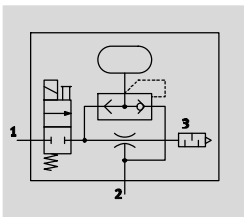

## General technical data – Standard

Constructional design		T-type															
Type		VN-05			VN-07			VN-10			VN-14			VN-20		VN-30	
Grid dimension	[mm]	14			14			14			18			24		24	
Integrated function		A	M	B	A	M	B	A	M	B	A	M	B	M	M		
Nominal size of laval nozzle	[mm]	0.45			0.7			0.95			1.4			2.0		3.0	
Ejector characteristic		High vacuum/Standard H (T-type)															
		High suction rate/Standard L (T-type)															
Pneumatic connection 1		QS-6	QS-6	QS-6	QS-6	QS-6	QS-6	QS-6	QS-6	QS-6	QS-8	QS-8	QS-8	QS-10	QS-10		
		G1/8	-	-	G1/8	-	-	G1/8	-	-	G1/4	-	-	-	-		
Vacuum connection		QS-6	QS-6	QS-6	QS-6	QS-6	QS-6	QS-6	QS-6	QS-6	QS-8	QS-8	QS-8	QS-12	QS-12		
		G1/8	-	-	G1/8	-	-	G1/8	-	-	G1/4	-	-	-	-		
Pneumatic connection 3		Silencer, minimal resistance															
Type of mounting (max. tightening torque)		Via through-holes (0.5 Nm)												Via through-holes (0.8 Nm)			
		Via H-rail												-			
		Via accessories															
Mounting position		Any															
Cleaning recommendation		Soapy water															

-||- Note: This product conforms to ISO 1179-1 and to ISO 228-1

# Vacuum generators VN-A/M/B, with additional functions

Technical data

General technical data – Inline		
Constructional design	Inline	
Type	VN-05	VN-07
Grid dimension [mm]	14.5	14.5
Integrated function	A	
Nominal size of laval nozzle [mm]	0.45	0.7
Ejector characteristic	High vacuum/Inline M High suction rate/Inline N	
Pneumatic connection 1	QS-6	
Vacuum connection	QS-6	
Type of mounting	Inline installation	
Mounting position	Any	
Cleaning recommendation	Soapy water	

Operating and environmental conditions				
Pneumatic connection	Via push-in fitting			Via female threads
Integrated function	A	M	B	A
Operating pressure [bar]	1 ... 8	2 ... 8		1 ... 8
Nominal operating pressure [bar]	6			
Operating medium	Compressed air in accordance with ISO 8573-1:2010 [7:4:4]			
Note on operating/pilot medium	Operation with lubricated medium not possible			
Ambient temperature [°C]	0 ... +60	0 ... +50		0 ... +60
Temperature of medium [°C]	0 ... +60	0 ... +50		0 ... +60
Corrosion resistance class CRC <sup>1)</sup>	1			2

1) Corrosion resistance class CRC 1 to Festo standard FN 940070

Low corrosion stress. For dry indoor applications or transport and storage protection. Also applies to parts behind covers, in the non-visible interior area, and parts which are covered in the application (e.g. drive trunnions).

Corrosion resistance class CRC 2 to Festo standard FN 940070

Moderate corrosion stress. Indoor applications in which condensation may occur. External visible parts with primarily decorative requirements for the surface and which are in direct contact with the ambient atmosphere typical for industrial applications.

Performance data – High vacuum																
Ejector characteristic	Standard H														Inline M	
Nominal size of laval nozzle [mm]	0.45			0.7			0.95			1.4		2.0	3.0	0.45	0.7	
Integrated function	A	M	B	A	M	B	A	M	B	A	M	B	M	M	A	A
Max. vacuum [%]	92			92			93			92		92	93	93	93	
Operating pressure for max. vacuum [bar]	4.9			4.4			3.5			3.5		3.5	3.7	4.3	4.3	
Max. suction rate with respect to atmosphere [l/min]	7.2			16.2			21.8			48.8		98	186	7.2	16.6	
Operating pressure for max. suction rate [bar]	3			3			3			4		2	3	2	2	
Air supply time at nominal operating pressure 6 bar (for 1 l volume) <sup>1)</sup> [s]	3.63	3.9		1.5	1.69		0.96	1.06		0.43	0.5		0.24	0.13	4.1	1.69
Noise level at nominal operating pressure 6 bar [dB (A)]	56			65			71			69		63	78	66	75	

1) Duration for vacuum purging down to a residual vacuum of -0.05 bar after switching off the operating pressure.

# Vacuum generators VN-A/M/B, with additional functions

Technical data

Performance data – High suction rate															
Ejector characteristic		Standard L										Inline N			
Nominal size of laval nozzle [mm]		0.45			0.7			0.95			1.4			0.45	0.7
Integrated function		A	M	B	A	M	B	A	M	B	A	M	B	A	A
Max. suction rate with respect to atmosphere [l/min]		13.6			30.9			40.5			92.6			13.3	32.6
Operating pressure for max. suction rate [bar]		5			4			5			5			5	4
Air supply time at nominal operating pressure 6 bar (for 1 l volume) <sup>1)</sup> [s]		1.93	1.97		0.79	0.83		0.62	0.67		0.28	0.32		2.24	0.89
Noise level at nominal operating pressure 6 bar [dB (A)]		52			64			72			69			68	78

1) Duration for vacuum purging down to a residual vacuum of -0.05 bar after switching off the operating pressure.

Technical data – Solenoid valve	
Operating voltage range [V DC]	21.6 ... 26.4
Duty cycle [%]	100
Protection class	IP40 (to EN 60 529)
Valve function	2/2-way valve
Manual override	By pushing

## Materials

Sectional view

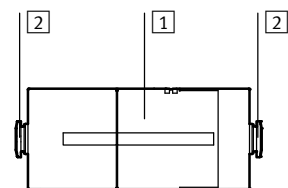
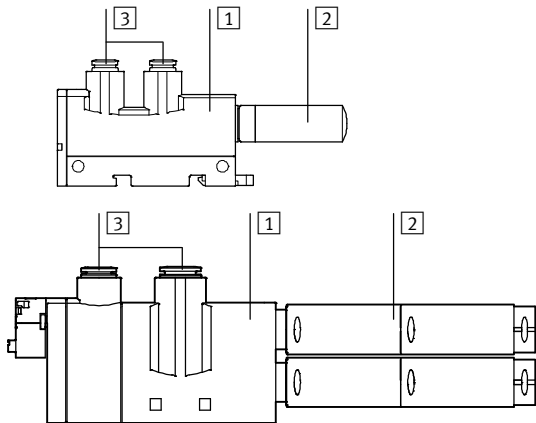

Vacuum generator VN – Standard		
1	Housing	PA-reinforced, POM-reinforced
2	Silencer	RO1 PE
		RO2 Wrought aluminium alloy, POM, PU foam
3	Push-in fitting	Nickel plated brass
-	Connecting thread	Anodised wrought aluminium alloy
-	Jet nozzle	Wrought aluminium alloy
-	Receiver nozzle	POM
-	Screws	Steel
-	Seals	NBR
Note on materials		RoHS-compliant
		Free of copper and PTFE
		RO2 Contains paint-wetting impairment substances

Vacuum generator VN – Inline		
1	Housing	PA-reinforced, POM-reinforced
2	Push-in fitting	Nickel plated brass
-	Jet nozzle	Wrought aluminium alloy
-	Receiver nozzle	POM
-	Seals	NBR
Note on materials		RoHS-compliant
		Free of copper and PTFE

# Vacuum generators VN-A/M/B, with additional functions

Technical data

## Vacuum $p_u$ as a function of operating pressure $p_1$

### High vacuum – Standard

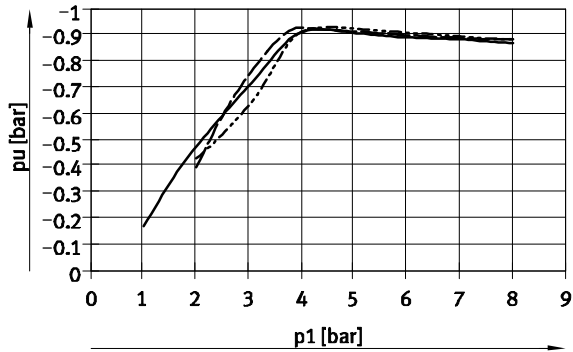

- VN-05-H
- - - VN-07-H
- · - VN-10-H

### High suction rate – Standard

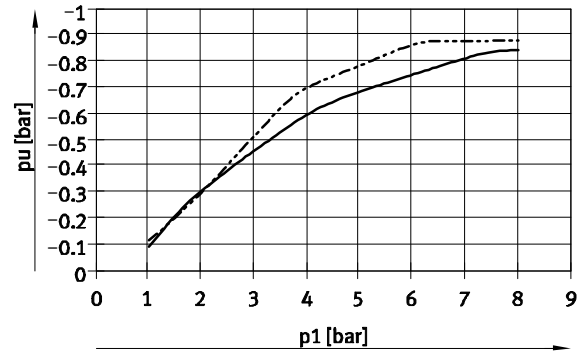

- VN-05-L
- - - VN-10-L

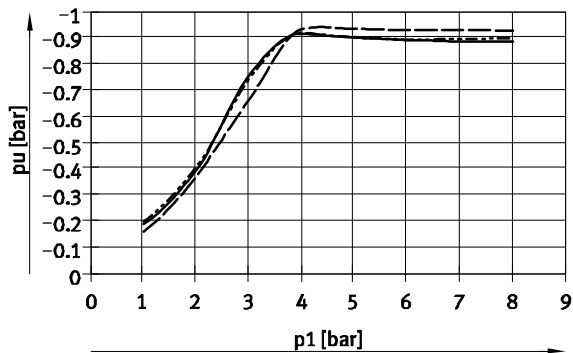

- VN-14-H
- - - VN-20-H
- · - VN-30-H

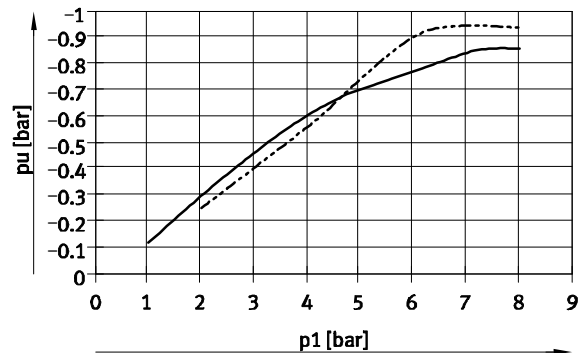

- VN-07-L
- - - VN-14-L

### High vacuum – Inline

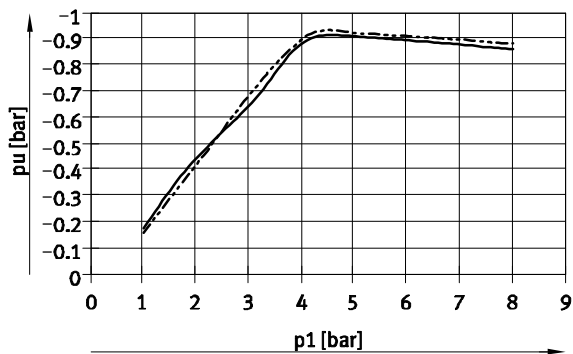

- VN-05-M
- - - VN-07-M

### High suction rate – Inline



- VN-05-N
- - - VN-07-N

# Vacuum generators VN-A/M/B, with additional functions

Technical data

## Evacuation time $t$ as a function of vacuum $p_u$ for 1 l volume at 6 bar operating pressure

High vacuum – Standard

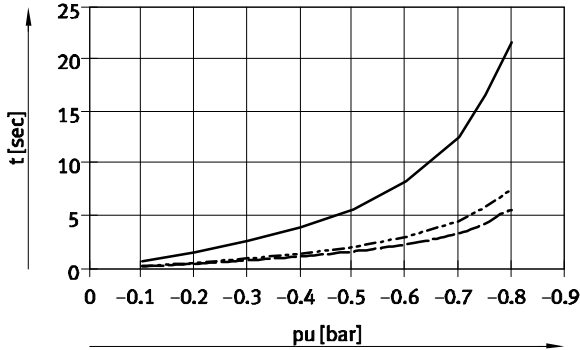

— VN-05-H  
 - - - VN-07-H  
 - · - VN-10-H

High suction rate – Standard

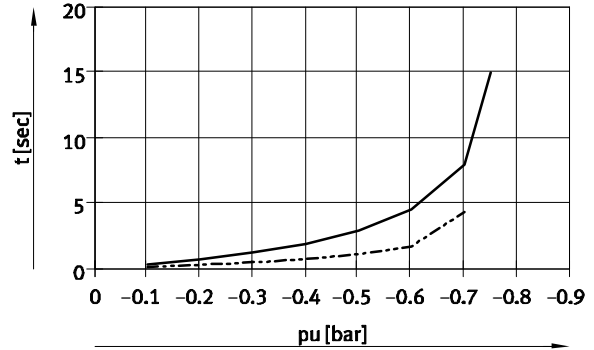

— VN-05-L  
 - - - VN-07-L

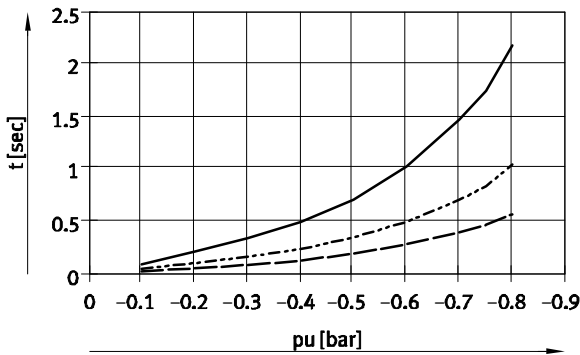

— VN-14-H  
 - - - VN-20-H  
 - · - VN-30-H

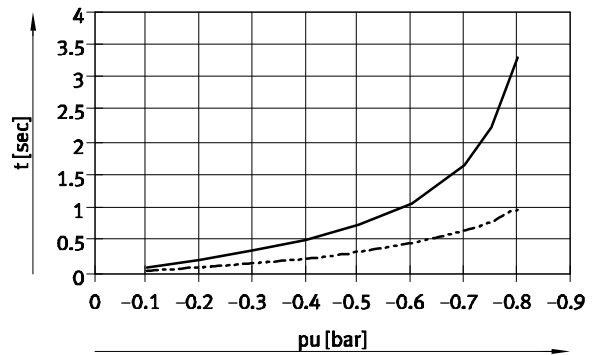

— VN-10-L  
 - - - VN-14-L

High vacuum – Inline

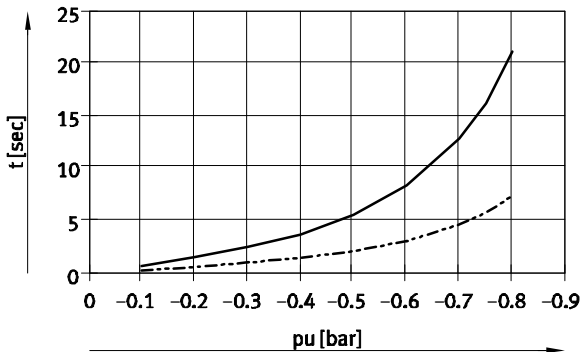

— VN-05-M  
 - - - VN-07-M

High suction rate – Inline

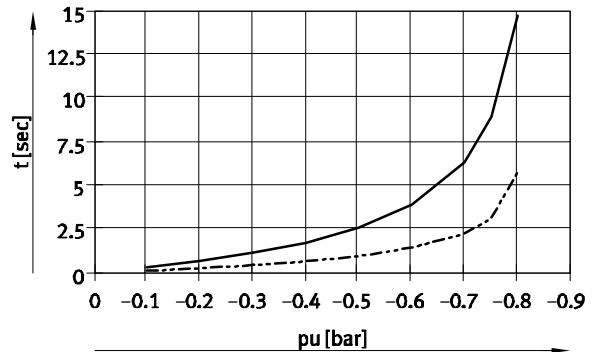

— VN-05-N  
 - - - VN-07-N

# Vacuum generators VN-A/M/B, with additional functions

Technical data

## Suction rate $q_{ns}$ (with respect to atmosphere) as a function of operating pressure $p_1$

High vacuum – Standard

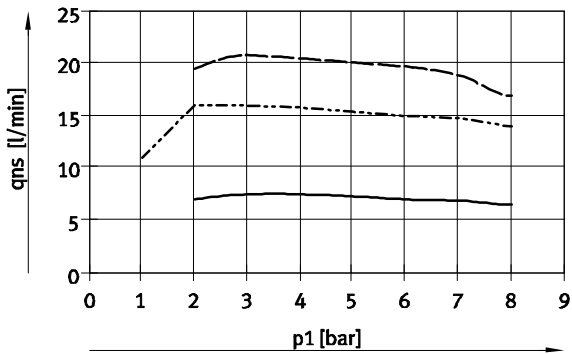

— VN-05-H  
 - - - VN-07-H  
 - · - VN-10-H

High suction rate – Standard

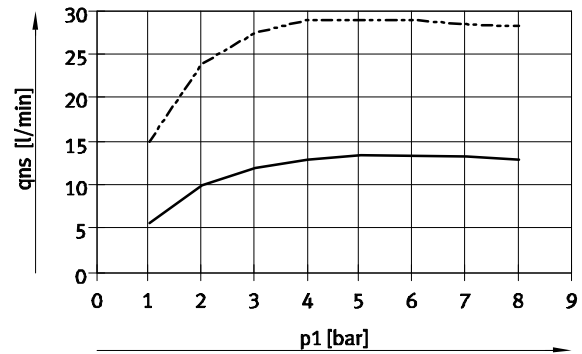

— VN-05-L  
 - - - VN-07-L

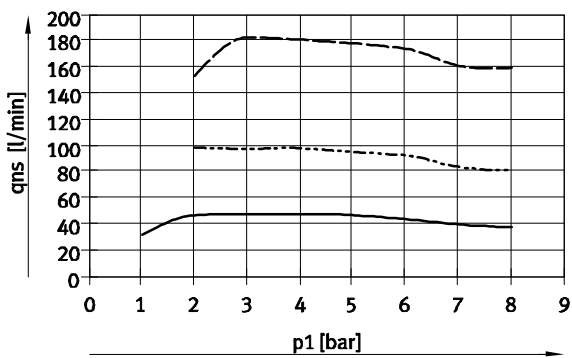

— VN-14-H  
 - - - VN-20-H  
 - · - VN-30-H

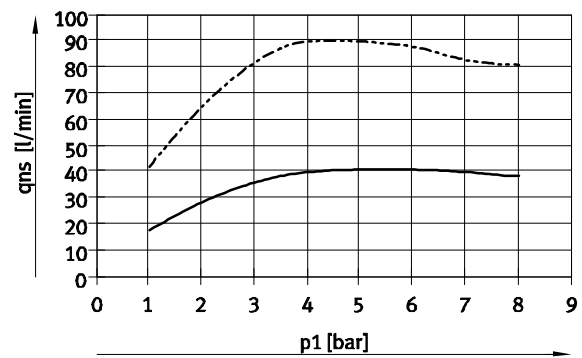

— VN-10-L  
 - - - VN-14-L

High vacuum – Inline

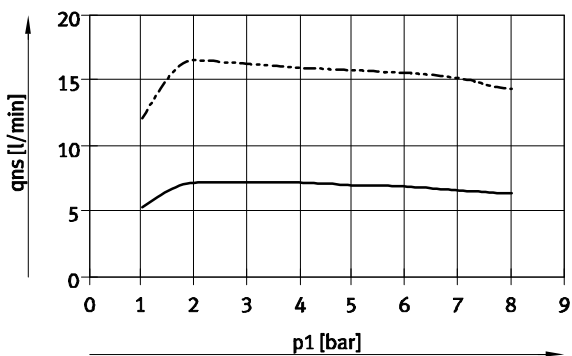

— VN-05-M  
 - - - VN-07-M

High suction rate – Inline

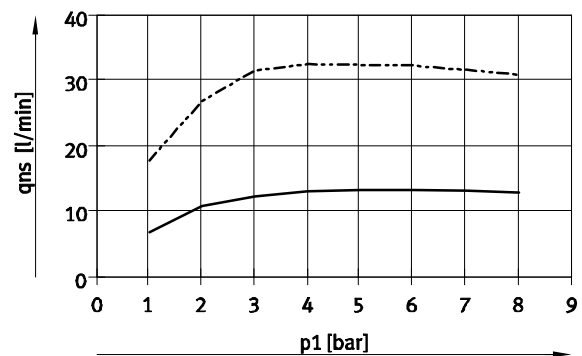

— VN-05-N  
 - - - VN-07-N

# Vacuum generators VN-A/M/B, with additional functions

Technical data

## Air consumption $q_n$ as a function of operating pressure $p_1$

High vacuum/high suction rate

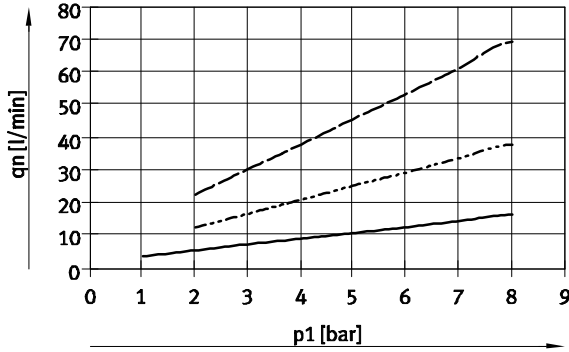

- VN-05
- VN-07
- - - - VN-10

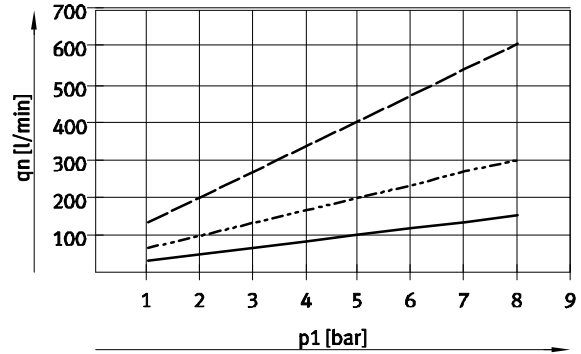

- VN-14
- VN-20
- - - - VN-30

## Dimensions – T-type/Standard, VN-05/07/10/14

Download CAD data → [www.festo.com](http://www.festo.com)

VN-...-T...-PQ...-VQ...-RO...-A

VN-...-T...-PI...-VI...-RO...-A

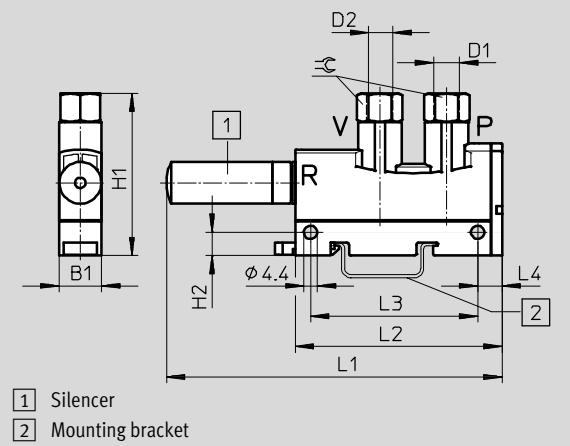
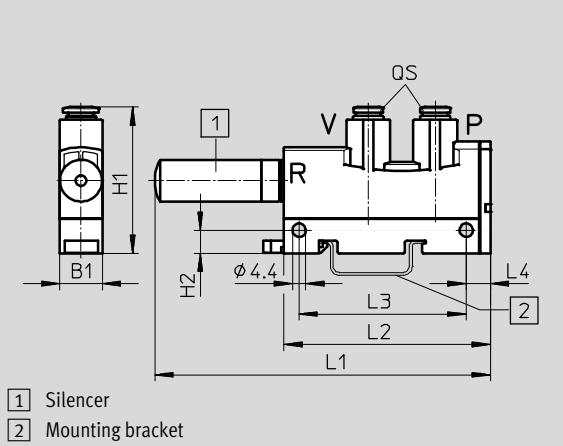

## VN-...-T...-PQ...-VQ...-RO...-M/B

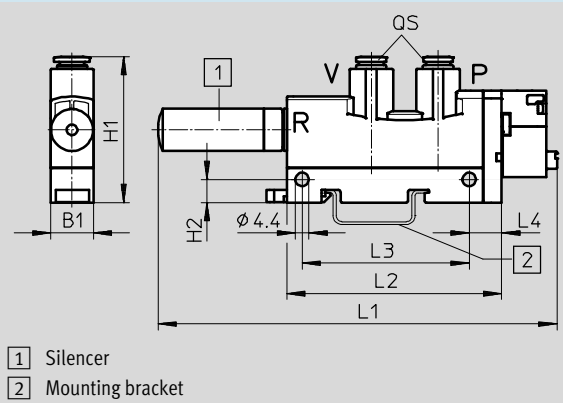



# Vacuum generators VN-A/M/B, with additional functions

Technical data

Type	B1	Connections		H1	H2	L1	L2	L3	L4	⌀
		P D1	V D2							
VN-05-...-T3-PQ2-VQ2-RO1-A	14	QS-6	QS-6	48	7.6	110	68	55	8	-
VN-07-...-T3-PQ2-VQ2-RO1-A						119				
VN-10-...-T3-PQ2-VQ2-RO1-A						110				
VN-05-...-T3-PI4-VI4-RO1-A		G1/8	G1/8	53		119				
VN-07-...-T3-PI4-VI4-RO1-A										
VN-10-...-T3-PI4-VI4-RO1-A										
VN-14-...-T4-PQ3-VQ3-RO2-A	18	QS-8	QS-8	50	7.5	166	98	63	8.7	-
VN-14-...-T4-PI5-VI5-RO2-A		G1/4	G1/4	62						17
VN-05-...-T3-PQ2-VQ2-RO1-M/B	14	QS-6	QS-6	48	7.6	132	71	55	10.7	-
VN-07-...-T3-PQ2-VQ2-RO1-M/B						141				
VN-10-...-T3-PQ2-VQ2-RO1-M/B										
VN-14-...-T4-PQ3-VQ3-RO2-M/B	18	QS-8	QS-8	50	7.5	192	106	63	16.4	-

Note: This product conforms to ISO 1179-1 and to ISO 228-1

## Dimensions – T-type/Standard, VN-20/30

Download CAD data → [www.festo.com](http://www.festo.com)

VN-...-T6-PQ4-VQ5-RO2-M

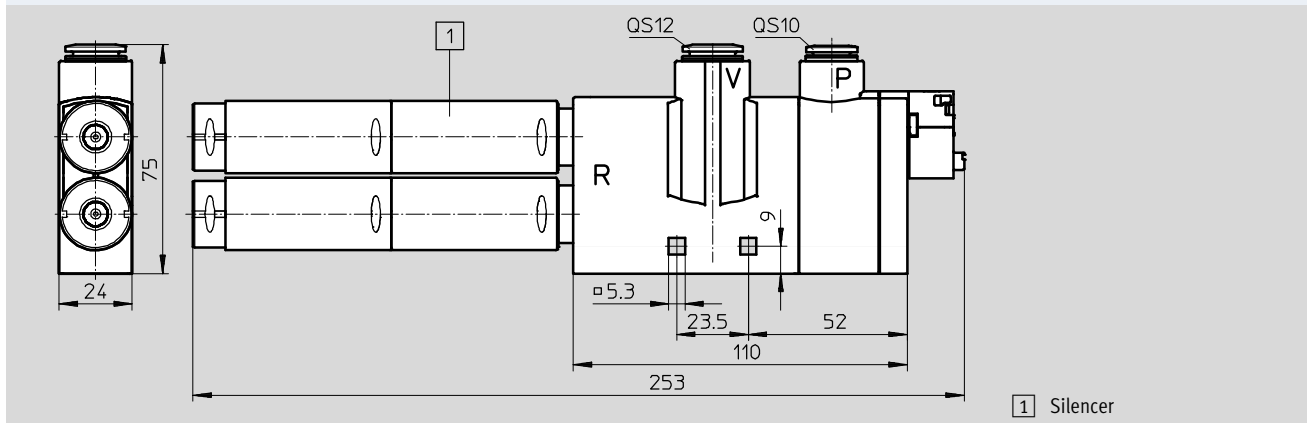

## Dimensions – Straight type/Inline, VN-05/07

Download CAD data → [www.festo.com](http://www.festo.com)

VN-05/07-...-I3-PQ2-VQ2-A

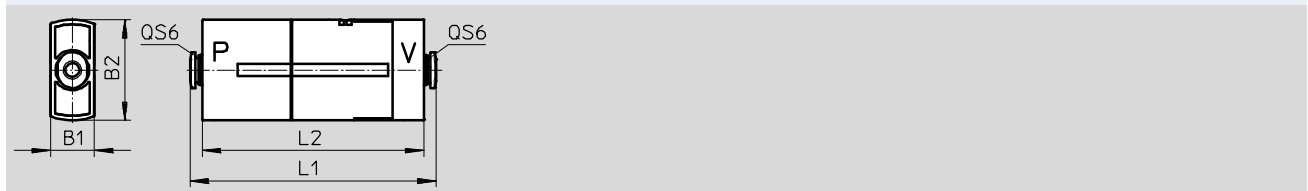

Type	B1	Connections		B2	L1	L2
		P	V			
VN-05-...-I3-PQ2-VQ2-A	14.5	QS-6	QS-6	33.1	81	73
VN-07-...-I3-PQ2-VQ2-A					97	89

# Vacuum generators VN-A/M/B, with additional functions

FESTO

Technical data

## ★ Core product range

Ordering data and weights – Standard						
T-type						
Nominal size of laval nozzle [mm]	Weight [g]	High vacuum H		Weight [g]	High suction rate L	
		Part No.	Type		Part No.	Type
With electrical on-off valve, pneumatic ejector pulse, push-in fitting and silencer						
0.95	–	–	–	63	★ 532641	VN-10-L-T3-PQ2-VQ2-R01-B
1.4	–	–	–	100	★ 532649	VN-14-L-T4-PQ3-VQ3-R02-B

Ordering data and weights – Standard						
T-type						
Nominal size of laval nozzle [mm]	Weight [g]	High vacuum H		Weight [g]	High suction rate L	
		Part No.	Type		Part No.	Type
With pneumatic ejector pulse, push-in fitting and silencer						
0.45	49	532620	VN-05-H-T3-PQ2-VQ2-R01-A	49	532621	VN-05-L-T3-PQ2-VQ2-R01-A
0.7	50	532628	VN-07-H-T3-PQ2-VQ2-R01-A	50	532629	VN-07-L-T3-PQ2-VQ2-R01-A
0.95	50	532638	VN-10-H-T3-PQ2-VQ2-R01-A	50	532639	VN-10-L-T3-PQ2-VQ2-R01-A
1.4	85	532646	VN-14-H-T4-PQ3-VQ3-R02-A	85	532647	VN-14-L-T4-PQ3-VQ3-R02-A
With pneumatic ejector pulse, female thread and silencer						
0.45	49	537225	VN-05-H-T3-PI4-VI4-R01-A	49	537226	VN-05-L-T3-PI4-VI4-R01-A
0.7	50	532632	VN-07-H-T3-PI4-VI4-R01-A	50	532633	VN-07-L-T3-PI4-VI4-R01-A
0.95	50	532642	VN-10-H-T3-PI4-VI4-R01-A	50	532643	VN-10-L-T3-PI4-VI4-R01-A
1.4	94	532719	VN-14-H-T4-PI5-VI5-R02-A	94	532720	VN-14-L-T4-PI5-VI5-R02-A
With electrical on-off valve, push-in fitting and silencer						
0.45	60	532618	VN-05-H-T3-PQ2-VQ2-R01-M	60	532619	VN-05-L-T3-PQ2-VQ2-R01-M
0.7	61	532626	VN-07-H-T3-PQ2-VQ2-R01-M	61	532627	VN-07-L-T3-PQ2-VQ2-R01-M
0.95	61	532636	VN-10-H-T3-PQ2-VQ2-R01-M	61	532637	VN-10-L-T3-PQ2-VQ2-R01-M
1.4	98	532644	VN-14-H-T4-PQ3-VQ3-R02-M	98	532645	VN-14-L-T4-PQ3-VQ3-R02-M
2.0	215	532656	VN-20-H-T6-PQ4-VQ5-R02-M	–	–	–
3.0	215	532662	VN-30-H-T6-PQ4-VQ5-R02-M	–	–	–
With electrical on-off valve, pneumatic ejector pulse, push-in fitting and silencer						
0.45	62	532622	VN-05-H-T3-PQ2-VQ2-R01-B	62	532623	VN-05-L-T3-PQ2-VQ2-R01-B
0.7	63	532630	VN-07-H-T3-PQ2-VQ2-R01-B	63	532631	VN-07-L-T3-PQ2-VQ2-R01-B
0.95	63	532640	VN-10-H-T3-PQ2-VQ2-R01-B	–	–	–
1.4	100	532648	VN-14-H-T4-PQ3-VQ3-R02-B	–	–	–

Ordering data and weights – Inline						
Inline						
Nominal size of laval nozzle [mm]	Weight [g]	High vacuum M		Weight [g]	High suction rate N	
		Part No.	Type		Part No.	Type
With pneumatic ejector pulse and push-in fitting						
0.45	38	532624	VN-05-M-I3-PQ2-VQ2-A	38	532625	VN-05-N-I3-PQ2-VQ2-A
0.7	41	532634	VN-07-M-I3-PQ2-VQ2-A	41	532635	VN-07-N-I3-PQ2-VQ2-A

Festo core product range

- ★ Ready for dispatch from the Festo factory in 24 hours
- ★ Ready for dispatch in 5 days maximum from stock

# Vacuum generator cartridges VN

Technical data

Function

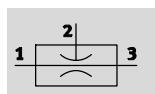

- - Temperature range  
0 ... +60 °C

- - Operating pressure  
1 ... 8 bar



General technical data						
Type		VN-05	VN-07	VN-10	VN-14	VN-20
Nominal size of laval nozzle	[mm]	0.45	0.7	0.95	1.4	2.0
Ejector characteristic		High vacuum, T-type/Standard H				
		High suction rate, T-type/Standard L				
Mounting position		Any				

Operating and environmental conditions		
Operating pressure	[bar]	1 ... 8
Nominal operating pressure	[bar]	6
Operating medium		Compressed air in accordance with ISO 8573-1:2010 [7:4:4]
Note on operating/pilot medium		Operation with lubricated medium not possible
Ambient temperature	[°C]	0 ... +60
Temperature of medium	[°C]	0 ... +60
Corrosion resistance class CRC <sup>1)</sup>		2

1) Corrosion resistance class CRC 2 to Festo standard FN 940070  
Moderate corrosion stress. Indoor applications in which condensation may occur. External visible parts with primarily decorative requirements for the surface and which are in direct contact with the ambient atmosphere typical for industrial applications.

Performance data – High vacuum						
Ejector characteristic		Standard H				
Nominal size of laval nozzle	[mm]	0.45	0.7	0.95	1.4	2.0
Max. vacuum	[%]	92	92	93	92	92
Operating pressure for max. vacuum	[bar]	4.9	4.4	3.5	3.5	3.5
Max. suction rate with respect to atmosphere	[l/min]	7.2	16.2	21.8	48.8	98
Operating pressure for max. suction rate	[bar]	3	3	3	2	2
Air supply time at nominal operating pressure 6 bar (for 1 l volume)	[s]	4.43	1.67	1.02	0.48	0.23

# Vacuum generator cartridges VN

Technical data

Performance data – High suction rate						
Ejector characteristic		Standard L				
Nominal size of laval nozzle	[mm]	0.45	0.7	0.95	1.4	2.0
Max. suction rate with respect to atmosphere	[l/min]	13.6	30.9	41.5	92.6	184.4
Operating pressure for max. suction rate	[bar]	5	4	5	5	5
Air supply time at nominal operating pressure 6 bar (for 1 l volume)	[s]	2.04	0.82	0.66	0.31	0.17

-  - Note

Twice the suction rate can be generated through parallel connection of two vacuum generator cartridges. The respective suction rate then

corresponds to the next highest performance level. Example: 2x20-H corresponds to 1x30-H

## Materials

Sectional view

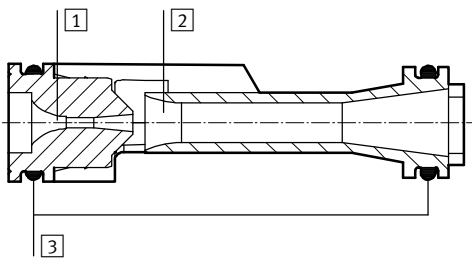

Vacuum generator cartridge VN-05/07/10/14/20		
1	Jet nozzle	Wrought aluminium alloy
2	Receiver nozzle	POM
3	Seals	NBR

-  - Note

The graphs plotting the technical data for the vacuum generator cartridge are the same as those for the vacuum generator VN-A/B/M.

➔ From page 37.

# Vacuum generator cartridges VN

Technical data

FESTO

## Dimensions

Download CAD data → [www.festo.com](http://www.festo.com)

VN-05

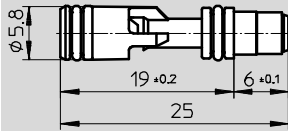

VN-07/10

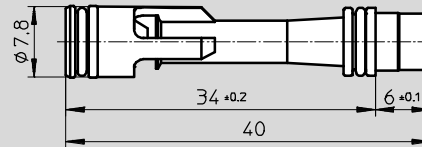

VN-14/20

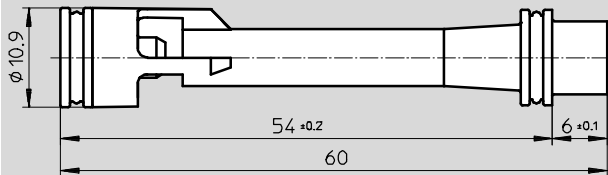

## Locating hole for the vacuum generator cartridge

Dimensions

Installation of the vacuum generator cartridge

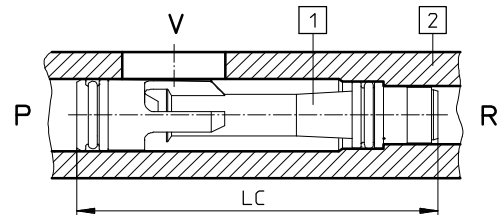
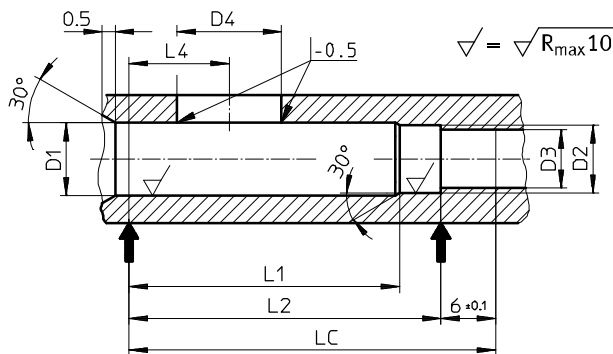

- 1 Vacuum generator cartridge
- 2 Customer-specific housing

Type	Dimensions of the locating hole						Vacuum port		
	D1 <sup>1)</sup> +0.05	D2	D3	L1	L2 ±0.2	LC <sup>2)</sup>	L4 ±0.2	D4 min. Ø <sup>3)</sup>	max. Ø
VN-05	6	5.7 +0.05	4.9 +0.1	14	19	25	9.5	3.0	3.5
VN-07	8	7.5 +0.05	6.5 +0.1	29	34	40	11	6.0	7.5
VN-10									
VN-14	11.1	10.7 -0.05	9.4 ±0.1	49	54	60	13	12.8	15.6
VN-20									

- 1) For D1 with Ø 11.1: Select a core diameter of 11.8 +0.1 for a G1/4 threaded connection
- 2) Length of the vacuum generator cartridge
- 3) Minimum cross section, Festo recommends the largest possible cross section

## Ordering data and weights

Nominal size of laval nozzle [mm]	Weight [g]	High vacuum H		Weight [g]	High suction rate L	
		Part No.	Type		Part No.	Type
0.45	0.65	547693	VN-05-H	0.65	547694	VN-05-L
0.7	1.65	547695	VN-07-H	1.65	547696	VN-07-L
0.95	1.65	547697	VN-10-H	1.65	547698	VN-10-L
1.4	3.75	547699	VN-14-H	3.75	547700	VN-14-L
2.0	3.75	547701	VN-20-H	3.75	547702	VN-20-L

# Vacuum generators VN

Accessories



## Mounting plate VN-...-BP-NRH

for vacuum generator VN  
for mounting on H-rail or via through-hole

Ambient temperature: 0 ... +60 °C

Material:

Plate VN-T2/T3/T4: POM reinforced

Plate VN-T6: PA reinforced

Slide: POM

RoHS-compliant

Free of copper and PTFE

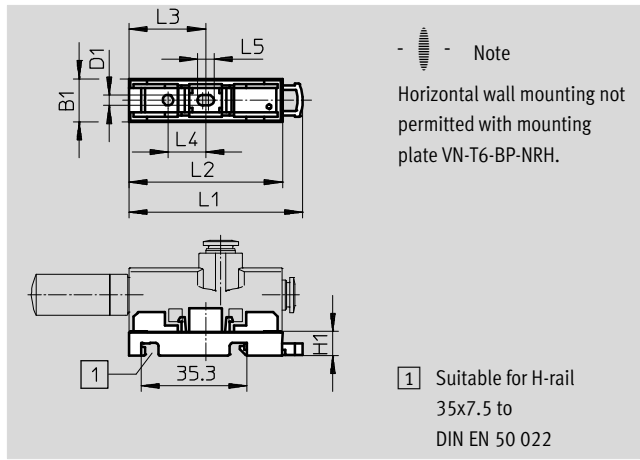
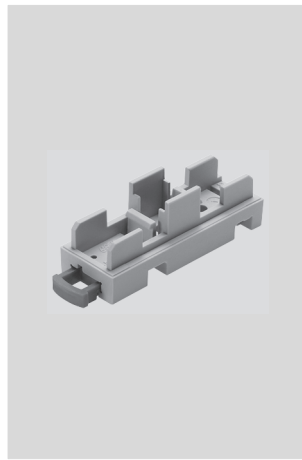

Dimensions and ordering data												
For grid dimension [mm]	B1	D1	H1	L1	L2	L3	L4	L5	CRC <sup>1)</sup>	Weight [g]	Part No.	Type
10	10.4	3.5	8	56.5	51	25.5	12.5	5.5	2	3.5	196951	VN-T2-BP-NRH
14	14.4	3.5	8	57.9	51.2	25.6	12.5	5.5	2	4.5	193641	VN-T3-BP-NRH
18	18.4									5.5	195279	VN-T4-BP-NRH
24	24	4.3	7.3	98	91	45.5	32.5	6.3	2	12.4	196956	VN-T6-BP-NRH

1) Corrosion resistance class CRC 2 to Festo standard FN 940070  
Moderate corrosion stress. Indoor applications in which condensation may occur. External visible parts with primarily decorative requirements for the surface and which are in direct contact with the ambient atmosphere typical for industrial applications.

## Mounting plate VN-...-BP

for vacuum generators VN-A/B/M  
For wall mounting with through hole  
for housing type T3/T4

Material:

Plate: Galvanised steel

RoHS-compliant

Free of copper and PTFE

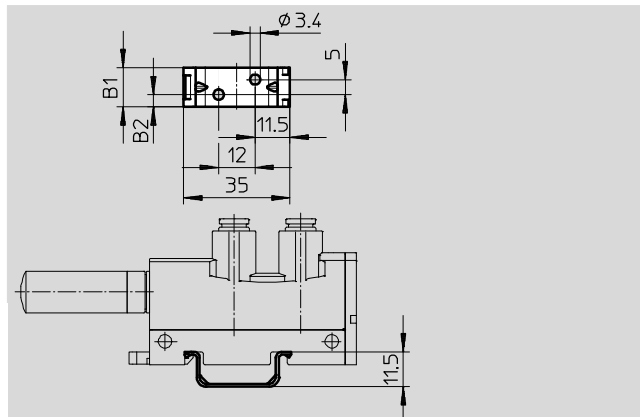

Dimensions and ordering data						
For grid dimension [mm]	B1	B2	CRC <sup>1)</sup>	Weight [g]	Part No.	Type
14	13	4	2	4.8	547436	VN-T3-BP
18	17	6		6.4	547437	VN-T4-BP



1) Corrosion resistance class CRC 2 to Festo standard FN 940070  
Moderate corrosion stress. Indoor applications in which condensation may occur. External visible parts with primarily decorative requirements for the surface and which are in direct contact with the ambient atmosphere typical for industrial applications.

# Vacuum generators VN

Accessories

FESTO

Ordering data – Silencer UO			Technical data → Internet: uo	
	For grid dimension [mm]	Pneumatic connection	Part No.	Type
	10 (VN-...-T2-...-R01 only)	M7	197582	UO-M7
	14	G $\frac{1}{8}$	197583	UO- $\frac{1}{8}$
	18	G $\frac{1}{4}$	197584	UO- $\frac{1}{4}$

Ordering data – Silencer AMTE				Technical data → Internet: amte	
	For grid dimension [mm]	Pneumatic connection	Part No.	Type	PU <sup>1)</sup>
Short design					
	10	M5	1206621	AMTE-M-H-M5	20
	14	G $\frac{1}{8}$	1206622	AMTE-M-H-G18	20
	18	G $\frac{1}{4}$	1206623	AMTE-M-H-G14	20
Long design					
	10	M5	★ 1205858	AMTE-M-LH-M5	20
	14	G $\frac{1}{8}$	★ 1205860	AMTE-M-LH-G18	20
	18	G $\frac{1}{4}$	★ 1205861	AMTE-M-LH-G14	20

1) Packaging unit

Ordering data – Silencer UOM			Technical data → Internet: uom	
	For grid dimension [mm]	Pneumatic connection	Part No.	Type
	18	G $\frac{1}{4}$	538432	UOM- $\frac{1}{4}$
	24	G $\frac{3}{8}$	538433	UOM- $\frac{3}{8}$

Ordering data – Silencer extension UOMS			Technical data → Internet: uoms	
	For grid dimension [mm]	Pneumatic connection	Part No.	Type
	18	–	538436	UOMS- $\frac{1}{4}$
	24	–	538437	UOMS- $\frac{3}{8}$



Festo core product range

- ★ Ready for dispatch from the Festo factory in 24 hours
- ☆ Ready for dispatch in 5 days maximum from stock

# Vacuum generators VN

Accessories

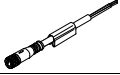
**FESTO**

Ordering data – Connecting cable NEBU-M8				Technical data → Internet: nebu	
	Electrical connection	Number of wires	Cable length [m]	Part No.	Type
	M8x1, straight socket	3	2.5	★ 541333	NEBU-M8G3-K-2.5-LE3
			5	★ 541334	NEBU-M8G3-K-5-LE3
	M8x1, angled socket	3	2.5	★ 541338	NEBU-M8W3-K-2.5-LE3
			5	★ 541341	NEBU-M8W3-K-5-LE3

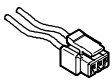
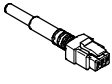
Ordering data – Plug socket with cable NEBV				Technical data → Internet: nebv	
	Cable composition	Product weight [g]	Cable length [m]	Part No.	Type
	2 individual cables	4	0.5	★ 566654	NEBV-H1G2-KN-0.5-N-LE2
		7	1	★ 566655	NEBV-H1G2-KN-1-N-LE2
		17	2.5	★ 566656	NEBV-H1G2-KN-2.5-N-LE2
		31	5	566657	NEBV-H1G2-KN-5-N-LE2
	2-wire cable	8	0.5	★ 566658	NEBV-H1G2-P-0.5-N-LE2
		16	1	★ 566659	NEBV-H1G2-P-1-N-LE2
		35	2.5	★ 566660	NEBV-H1G2-P-2.5-N-LE2
		70	5	566661	NEBV-H1G2-P-5-N-LE2

Festo core product range

- ★ Ready for dispatch from the Festo factory in 24 hours
- ☆ Ready for dispatch in 5 days maximum from stock



# Festo - Your Partner in Automation



**1 Festo Inc.**  
5300 Explorer Drive  
Mississauga, ON L4W 5G4  
Canada

**Festo Customer Interaction Center**  
Tel: 1 877 463 3786  
Fax: 1 877 393 3786  
Email: [customer.service.ca@festo.com](mailto:customer.service.ca@festo.com)



**2 Festo Pneumatic**  
Av. Ceylán 3,  
Col. Tequesquináhuac  
54020 Tlalneantla,  
Estado de México

**Multinational Contact Center**  
01 800 337 8669  
[ventas.mexico@festo.com](mailto:ventas.mexico@festo.com)



**3 Festo Corporation**  
1377 Motor Parkway  
Suite 310  
Islandia, NY 11749

**Festo Customer Interaction Center**  
1 800 993 3786  
1 800 963 3786  
[customer.service.us@festo.com](mailto:customer.service.us@festo.com)



**4 Regional Service Center**  
7777 Columbia Road  
Mason, OH 45040

Connect with us



[www.festo.com/socialmedia](http://www.festo.com/socialmedia)



[www.festo.com](http://www.festo.com)

Subject to change