

Vacuum generators VAD-M

FESTO



Vacuum generators

Key features

FESTO

Product overview

Vacuum generator

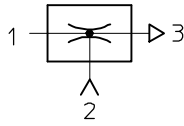

All Festo vacuum generators have a single-stage design and operate according to the venturi principle. The product families described below

have been designed for a wide range of applications. The different performance classes of the individual

product families make it possible to select vacuum generators tailored to suit specific requirements.

Standard and inline ejectors

VN-...

Technical data → Internet: vn



- Nominal size 0.45 ... 3 mm
- Max. vacuum 93%
- Temperature range 0 ... +60 °C
- A range of extremely effective generators suitable for use directly in the workplace
- Available as straight or T-shaped housing
- Low space requirement
- Low-cost
- No wearing parts
- Extremely fast evacuation time
- Vacuum switch (optional)
- Optional with additional functions:
 - integrated eject pulse
 - electric control for vacuum ON/OFF
 - combination of eject pulse and control

VAD-.../VAK-...

Technical data → Internet: vad



- Nominal size 0.5 ... 1.5 mm
- Max. vacuum 80%
- Temperature range -20 ... +80 °C
- Range of vacuum generators with sturdy aluminium casing
- VAK-...: Built-in reservoir
- VAD-...: Connection for additional external reservoir
- Maintenance-free
- VAK-...: Reliable setting down of workpieces

Vacuum generators

Key features

Compact ejectors

VADM-.../VADMI-...

Technical data → Internet: vadm



- Nominal size
0.45 ... 3 mm
- Max. vacuum
88%
- Temperature range
0 ... +60 °C
- Compact design
- Minimal installation work required
- Short response times
- Built-in solenoid valve (on/off)
- VADMI-...: Additional built-in solenoid valve for ejector pulse
- Filter with display
- Air-saving circuit (optional)
- Vacuum switch (optional)
- Reliable setting down of workpieces

VAD-M-.../VAD-M...-I-...

→ 6

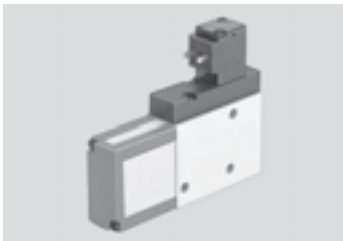

- Nominal size
0.7 ... 2 mm
- Max. vacuum
85%
- Temperature range
0 ... +40 °C
- Compact design
- Minimal installation work required
- Short response times
- Built-in solenoid valve (on/off)
- VAD-M-I-...: Additional built-in solenoid valve for ejector pulse
- Reliable setting down of workpieces

Vacuum generators VAD-M

Key features

At a glance

- Compact and sturdy design
- Short switching times thanks to integrated solenoid valves
- With manual override
- Maintenance-free because there are no moving parts
- With integrated silencer for reducing exhaust noise

Vacuum generators VAD-M...-I...

The compressed air supply of these vacuum generators is controlled by the built-in solenoid valve.

When the electrical power supply is switched on, the valve is actuated and the flow of compressed air from 1 (P) to 3 (R) generates a vacuum at port 2, operating on the ejector principle.

Suction stops when the supply power to the valve is switched off.

Workpieces with smooth, impervious surfaces are picked up and retained.

- Built-in solenoid valve for:
 - Vacuum ON/OFF

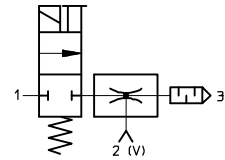

Vacuum generator VAD-M...-I... with ejector pulse

With two integrated solenoid valves for vacuum ON/OFF and ejector pulse for rapid purging of vacuum, plus manual override

Compressed air enters the vacuum generator following the application of a voltage signal to the integrated solenoid valve, thereby creating a vacuum.

Once the voltage is switched off at the vacuum valve (B) and switched on at the ejector valve (A), the vacuum is rapidly purged at connection 2 (V) as a result of the application of pressure.

- Two integrated solenoid valves:
 - Vacuum ON/OFF
 - Ejector pulse

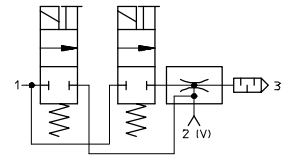

Vacuum generators VAD-M

Peripherals overview and type codes

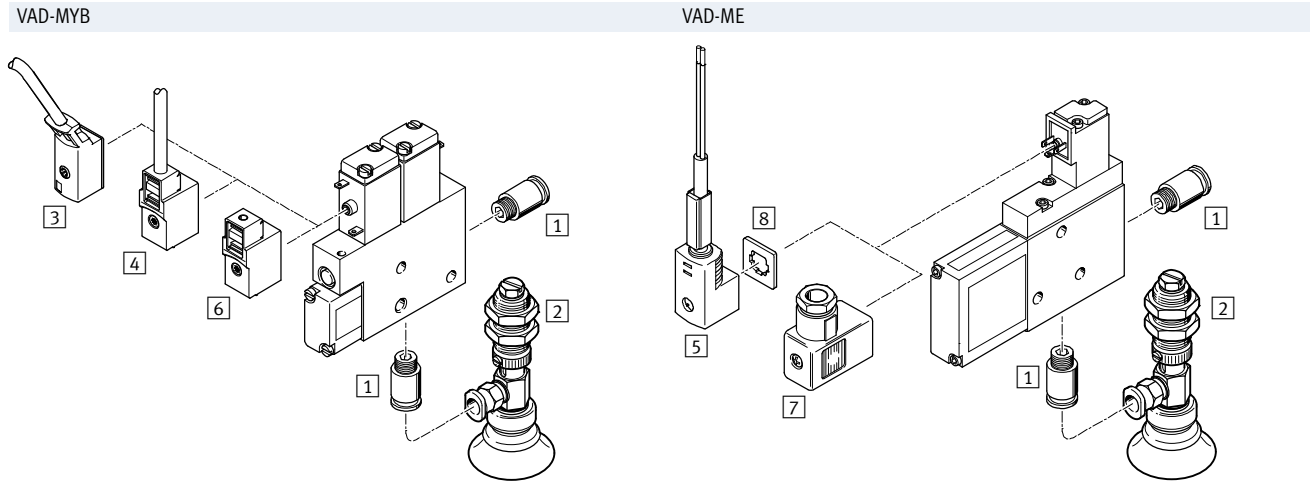

Mounting attachments and accessories		VAD-MYB	VAD-ME	→ Page/Internet
1	Push-in fitting QS	■	■	qs
2	Suction gripper ESG	■	■	esg
3	Connecting cable KMYZ-2	■	-	kmyz-2
4	Plug socket with cable KMYZ-4	■	-	kmyz-4
5	Plug socket with cable KME-1	-	■	kme-1
6	Plug socket MSSD-ZBZC	■	-	mssd-zbzc
7	Plug socket MSSD-E	-	■	mssd-e
8	Illuminating seal ME-LD	-	■	me-ld

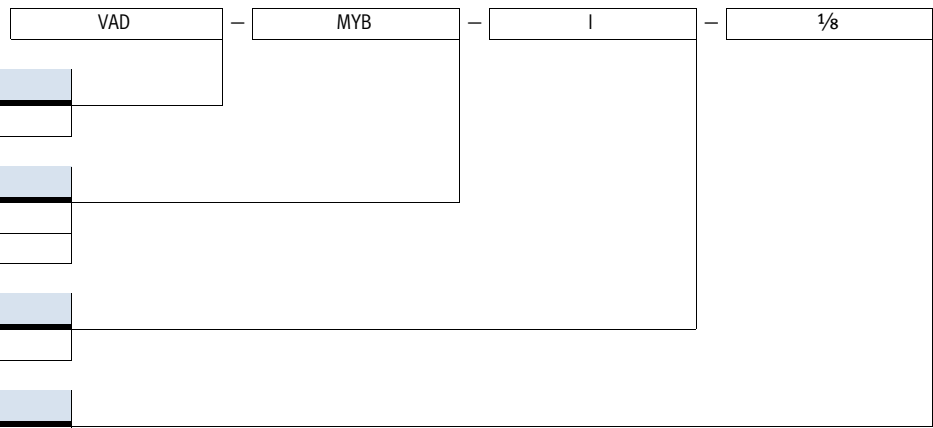

Type	
VAD	Vacuum generator, electrical

Solenoid coils	
MYB	Solenoid coil
ME	Solenoid coil

Functions	
I	With ejector pulse

Connection sizes	
1/8	G1/8 thread
1/4	G1/4 thread
3/8	G3/8 thread

- [Symbol] - Note
Possible combinations can be found in the ordering data.

Vacuum generators VAD-M

FESTO

Technical data

Function

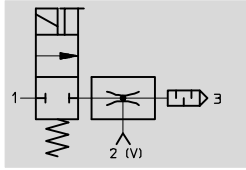

-  - Temperature range
0 ... +40 °C

-  - Operating pressure
1.5 ... 8 bar

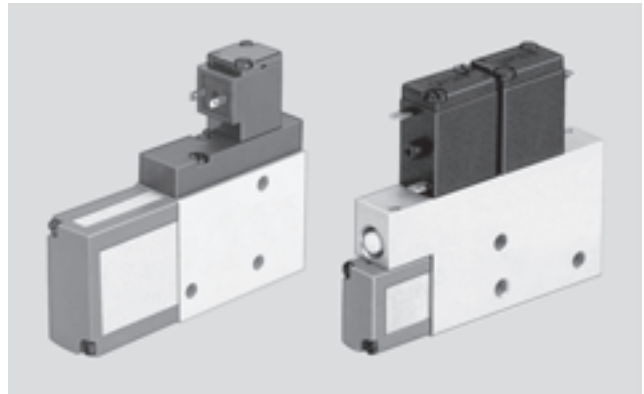

General technical data				
Type	VAD-MYB-...	VAD-ME-...		
Size	G $\frac{1}{8}$	G $\frac{1}{8}$	G $\frac{1}{4}$	G $\frac{3}{8}$
Design	Slim rectangular			
Operating medium	Compressed air in accordance with ISO 8573-1:2010 [7:4:4]			
Note on operating/pilot medium	Operation with lubricated medium not possible			
Mounting position	Any			
Ejector features	High vacuum			
Type of mounting	Via female threads			
Pneumatic connection 1/2	M5/G $\frac{1}{8}$	G $\frac{1}{8}$ /G $\frac{1}{8}$	G $\frac{1}{8}$ /G $\frac{1}{4}$	G $\frac{1}{4}$ /G $\frac{3}{8}$
Nominal size of laval nozzle [mm]	0.7	0.95	1.4	2.0
Max. vacuum [%]	85			
Operating pressure [bar]	1.5 ... 8			
Duty cycle [%]	100			
Protection class	IP65			

Ambient conditions		
Variant	VAD-M...-...	
Ambient temperature [°C]	0 ... +40	
Corrosion resistance CRC ¹⁾	2	

1) Corrosion resistance class CRC 2 to Festo standard FN 940070

Moderate corrosion stress. Indoor applications in which condensation may occur. External visible parts with primarily decorative requirements for the surface and which are in direct contact with the ambient atmosphere typical for industrial applications.

Weights [g]				
Type	VAD-MYB-...	VAD-ME-...		
Size	G $\frac{1}{8}$	G $\frac{1}{8}$	G $\frac{1}{4}$	G $\frac{3}{8}$
VAD-M...	80	125	210	240
VAD-M...-I-...	135	160	250	280

Vacuum generators VAD-M

Technical data

Vacuum ΔP_u as a function of operating pressure p

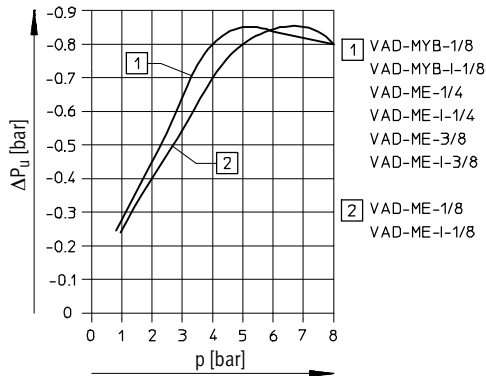

Evacuation time t [s] for 1 litre volume at 6 bar operating pressure

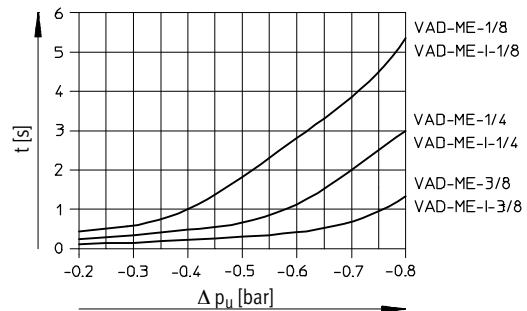
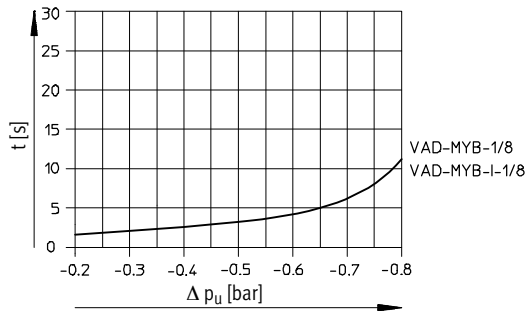

Air consumption Q as a function of operating pressure p

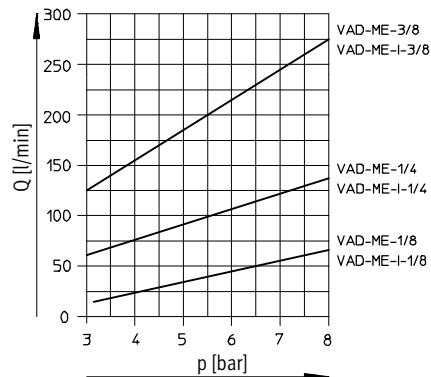
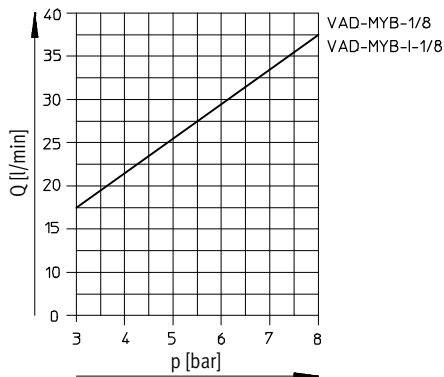

Efficiency η as a function of vacuum Δp at P_{nom} 6 bar

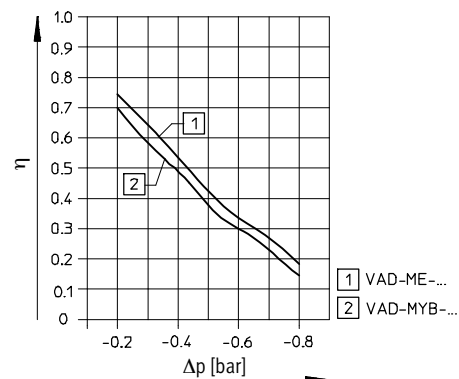

Vacuum generators VAD-M

Technical data

FESTO

Dimensions

VAD-MYB-1/8

VAD-ME-1/8/-1/4/-3/8

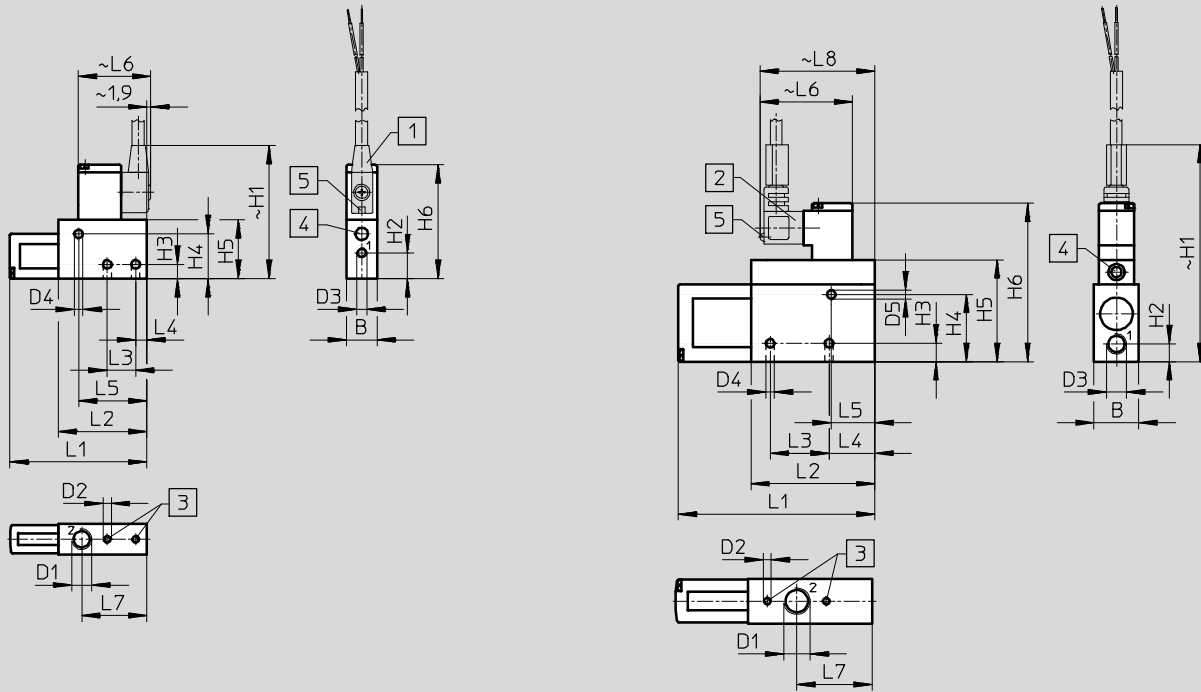

1 Connecting cable KMYZ-2-24-... with 2-wire cable, 2.5 or 5 m long, \varnothing 3.4 mm (2x 0.25 mm²)

2 Socket type KME-1-24-... with 2-wire cable, 2.5 or 5 m long, \varnothing 5.6 mm (2x 0.75 mm²)

3 Mounting thread
4 Manual override
5 Yellow LED

Type	B	D1	D2	D3	D4	D5	H1	H2	H3	H4
VAD-MYB-1/8	15	G1/8	M4	M5	4.2	-	62.5	12.7	7	22
VAD-ME-1/8	18	G1/8	M4	G1/8	4.2	3.2	93	14.2	6.5	20
VAD-ME-1/4	22	G1/4	M4	G1/8	4.2	4.2	106.8	8.7	9	33
VAD-ME-3/8	22	G3/8	M5	G1/4	5.2	5.2	113.1	11	10	39

Type	H5	H6	L1	L2	L3	L4	L5	L6	L7	L8
VAD-MYB-1/8	29	56	67.2	43.5	14	5.5	33.5	34.6	-	-
VAD-ME-1/8	36	64	76	61	27	19	30.5	48	32.5	58
VAD-ME-1/4	50	77.8	96.6	61	29	22.5	21.5	48	37	58
VAD-ME-3/8	56	84.1	101.8	61	32	23.5	21.5	48	39.5	58

Vacuum generators VAD-M

Technical data

FESTO

Dimensions

VAD-MYB-I-1/8

VAD-ME-I-1/8/-1/4/-3/8

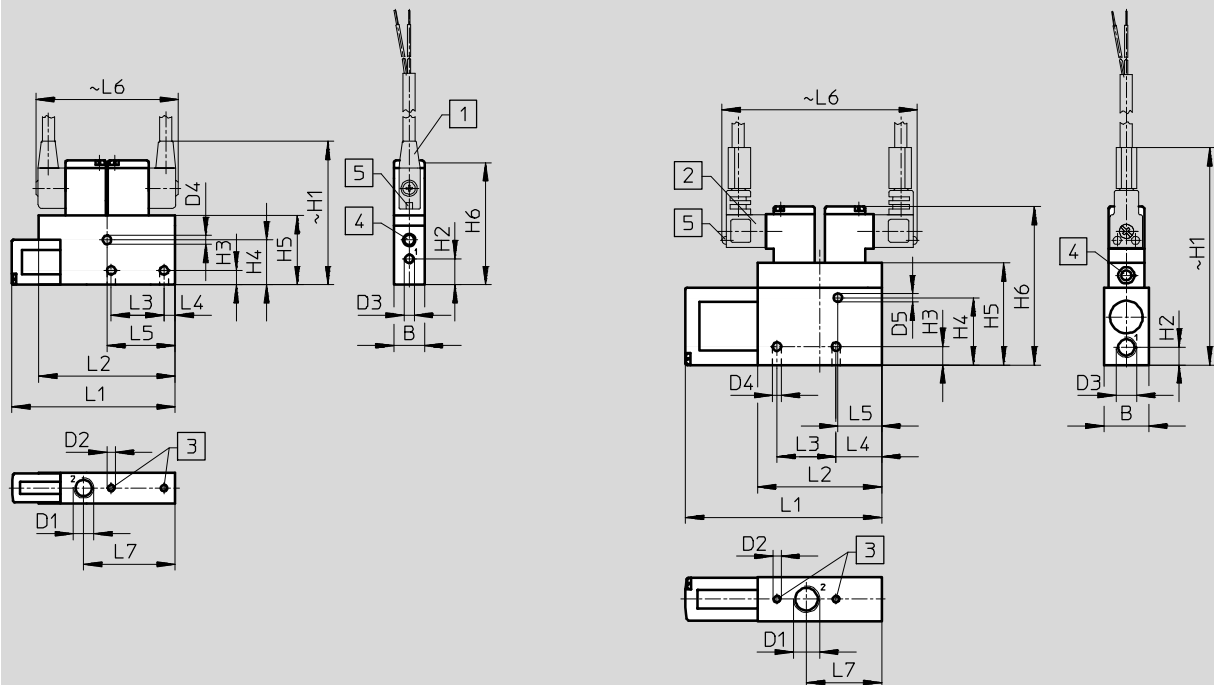

1 Connecting cable KMYZ-2-24-... with 2-wire cable, 2.5 or 5 m long, \varnothing 3.4 mm (2x 0.25 mm²)

2 Socket type KME-1-24-... with 2-wire cable, 2.5 or 5 m long, \varnothing 5.6 mm (2x 0.75 mm²)

3 Mounting thread
4 Manual override
5 Yellow LED

Type	B1	D1	D2	D3	D4	D5	H1	H2	H3	H4
VAD-MYB-I-1/8	15	G1/8	M4	M5	4.2	-	67.5	12.7	7	22
VAD-ME-I-1/8	18	G1/8	M4	G1/8	4.2	3.2	93	14.2	6.5	20
VAD-ME-I-1/4	22	G1/4	M4	G1/8	4.2	4.2	106.8	8.7	9	33
VAD-ME-I-3/8	22	G3/8	M5	G1/4	5.2	5.2	113.1	11	10	39

Type	H5	H6	L1	L2	L3	L4	L5	L6	L7
VAD-MYB-I-1/8	34	58.5	80.2	67	26	5.5	33.5	70	45
VAD-ME-I-1/8	36	64	76	61	27	19	30.5	96	32.5
VAD-ME-I-1/4	50	77.8	96.6	61	29	22.5	21.5	96	37
VAD-ME-I-3/8	56	84	101.8	61	32	23.5	21.5	96	39.5

Ordering data

Pneumatic connection	Solenoid coils	Without ejector pulse		With ejector pulse	
		Part No.	Type	Part No.	Type
G1/8	MYB	35 553	VAD-MYB-1/8	35 530	VAD-MYB-I-1/8
G1/8	ME	35 554	VAD-ME-1/8	35 531	VAD-ME-I-1/8
G1/4	ME	35 555	VAD-ME-1/4	35 532	VAD-ME-I-1/4
G3/8	ME	35 556	VAD-ME-3/8	35 533	VAD-ME-I-3/8

Festo - Your Partner in Automation



1 Festo Inc.
5300 Explorer Drive
Mississauga, ON L4W 5G4
Canada

Festo Customer Interaction Center
Tel: 1 877 463 3786
Fax: 1 877 393 3786
Email: customer.service.ca@festo.com

2 Festo Pneumatic
Av. Ceylán 3,
Col. Tequesquináhuac
54020 Tlalnepantla,
Estado de México

Multinational Contact Center
01 800 337 8669
ventas.mexico@festo.com

3 Festo Corporation
1377 Motor Parkway
Suite 310
Islandia, NY 11749

Festo Customer Interaction Center
1 800 993 3786
1 800 963 3786
customer.service.us@festo.com

4 Regional Service Center
7777 Columbia Road
Mason, OH 45040

Connect with us



www.festo.com/socialmedia



www.festo.com

Subject to change