

Parallel grippers HGPLE, sturdy with long stroke, electric

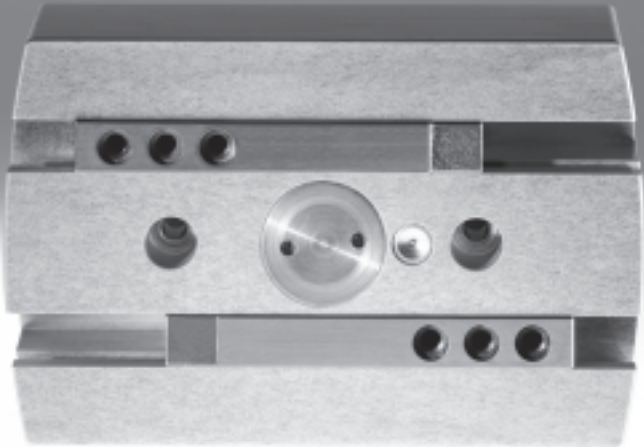

Parallel grippers HGPLE, sturdy with long stroke, electric

Key features

At a glance

With free, speed-controlled selection of the gripping positions, flexible gripping is no longer a problem with the parallel gripper HGPLE. Its long

stroke means it can be used with workpieces of different sizes. The option to adjust the gripping force

makes the HGPLE ideal for soft or very delicate workpieces. It also grips large and heavy workpieces reliably.

Economical

- A "pre-holding position" enables the HGPLE to stop its gripper fingers just short of the workpiece, thus reducing gripping times to an absolute minimum. The HGPLE offers impressively short opening

and closing times of 0.6 s, even with workpiece sizes that require the entire stroke.

- The installation complexity is minimal as only one cable is required (from the controller to the gripper).

Flexible

As an integral component of the multi-axis modular system, the HGPLE offers identical interfaces to the pneumatic parallel gripper HGPL. It is actuated on-site using the proven motor controller SFC-DC.

Sturdy

The T-slot provides the HGPLE very high torque resistance as well as very high precision.

Everything from a single source

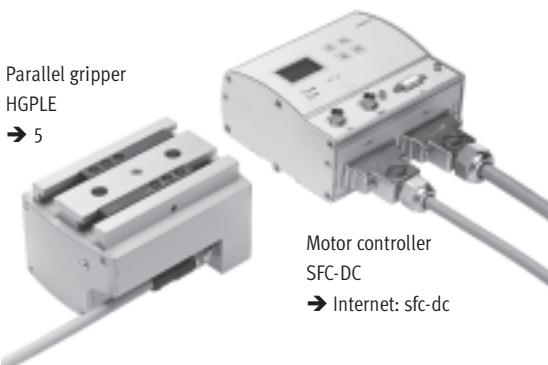

The parallel gripper and motor controller SFC form one unit.

- Thanks to the protection class IP54, the SFC can be mounted close to the HGPLE, either:
 - via central supports or
 - on a H-rail
- The motor controller SFC is available with or without control panel
- Easy actuation via:
 - Profibus
 - CANopen
 - DeviceNet

Parameterisation possible via:

- Control panel:
 - Suitable for simple position sequences
- FCT (Festo Configuration Tool) configuration package:
 - Parameterisation via RS 232 interface
 - Windows-based PC user interface, Festo Configuration Tool
 - Tool is included in scope of delivery



 **Note**
 These grippers are not suitable for the following or similar application examples:

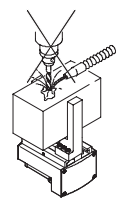

- Aggressive media
- Machining

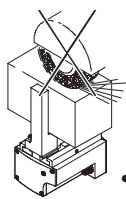

- Grinding dust

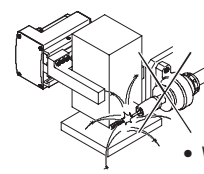

- Welding splashes

Parallel grippers HGPLE, sturdy with long stroke, electric

Key features and peripherals overview

FESTO

Mounting options

Direct mounting
from above

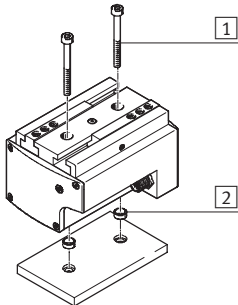

- 1 Mounting screws
- 2 Centring sleeves

from underneath

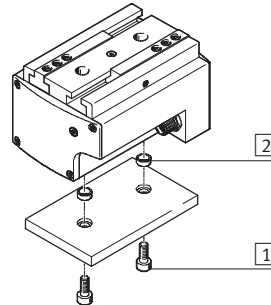

- 1 Mounting screws
- 2 Centring sleeves

Peripherals overview

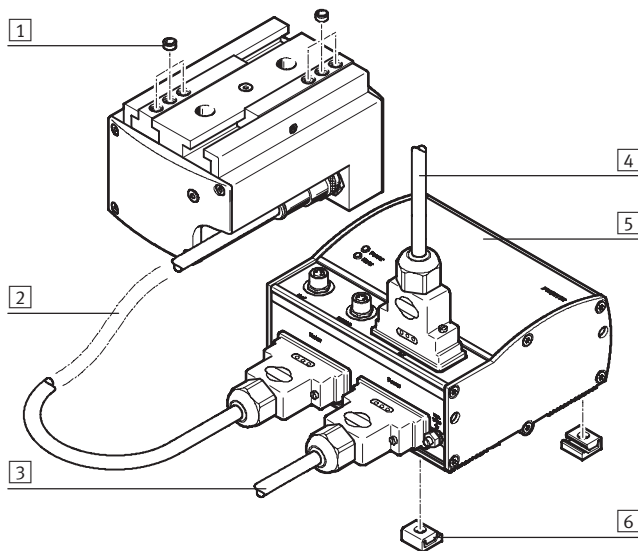

System product for handling and assembly technology

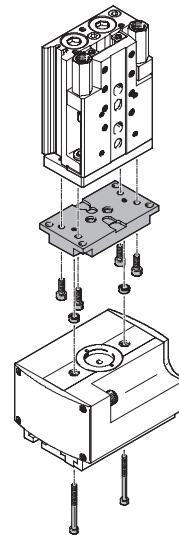

Accessories			
Type	Brief description	→ Page/Internet	
1 Centring sleeve ZBH	For centring attachments	10	
2 Motor cable KMTR	Connecting cable between motor and motor controller	sfc-dc	
3 Supply line KPWR	Power supply line; load and logic power supplies are isolated	sfc-dc	
4 Plug FBS, FBA	For fieldbus interface	sfc-dc	
5 Motor controller SFC	For parameterising and positioning the parallel gripper	sfc-dc	
6 Central support MUP	– For mounting the motor controller – The motor controller can also be mounted on a H-rail	sfc-dc	
– Gripper jaw blank BUB-HGPL	Blank specially matched to the gripper jaws for custom building of gripper fingers	10	

Parallel grippers HGPLE, sturdy with long stroke, electric

Type codes

		HGPLE	-	25	-	40	-	2.8	-	DC	-	VCSC	-	G85
Type														
HGPLE	Parallel gripper													
Size														
Stroke [mm] per gripper jaw														
Lead screw pitch														
2.8	2.8 mm													
Type of motor														
DC	DC motor													
Nominal voltage/plug type														
VCSC	24 V													
Gear reduction														
G85	85:1													

Parallel grippers HGPLE, sturdy with long stroke, electric

FESTO

Technical data

Function

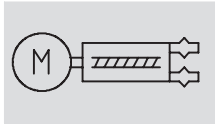

-  - Size
25 mm

-  - Stroke
80 mm



General technical data	
Constructional design	Electrically driven gripper Synchronised gripper jaws
Mode of operation	Double-acting
Gripper function	Parallel
Guide	Plain-bearing guide with T-slot
Number of gripper jaws	2
Stroke per gripper jaw, adjustable [mm]	0 ... 40
Electrical connection	12-pin M12x1 Plug
Repetition accuracy ¹⁾ [mm]	≤ 0.05
Max. interchangeability [mm]	≤ 0.2
Max. gripper jaw backlash ²⁾ [mm]	≤ 0.05
Rotational symmetry [mm]	≤ 0.2
Homing	Negative fixed stop block Positive fixed stop block
Position sensing	Via integrated angular displacement encoder
Type of mounting	Via through-holes and centring sleeves Via female thread and centring sleeves
Mounting position	Any
Product weight [g]	1,680

1) End-position drift under constant conditions of use with 100 consecutive strokes in the direction of movement of the gripper jaws

2) In the direction of movement of the gripper jaws

Electrical data for motor	
Type of motor	DC servo motor
Nominal operating voltage [V DC]	24

Operating and environmental conditions	
Ambient temperature [°C]	10 ... 40
Protection class	IP54
Noise level [dB A]	≤ 60
CE mark (see declaration of conformity)	To EU EMC Directive
Corrosion resistance class CRC ¹⁾	2

1) Corrosion resistance class 2 as per Festo standard 940 070

Components subject to moderate corrosion stress. Externally visible parts with primarily decorative surface requirements which are in direct contact with a normal industrial environment or media such as coolants or lubricating agents.

Parallel grippers HGPLE, sturdy with long stroke, electric

Technical data

Materials

Sectional view

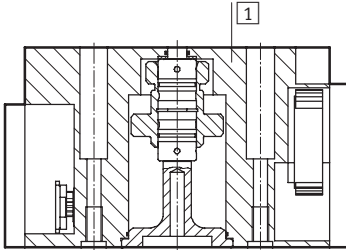

Parallel gripper

1	Housing	Wrought aluminium alloy, coated with CompCote
-	Gripper jaw	Hardened steel
-	Note on materials	Free of copper, PTFE and silicone
		RoHS-compliant

Gripping force F as a function of travel speed v and lever arm x

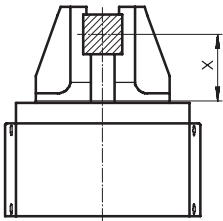

Gripping force F_h per gripper jaw
opening

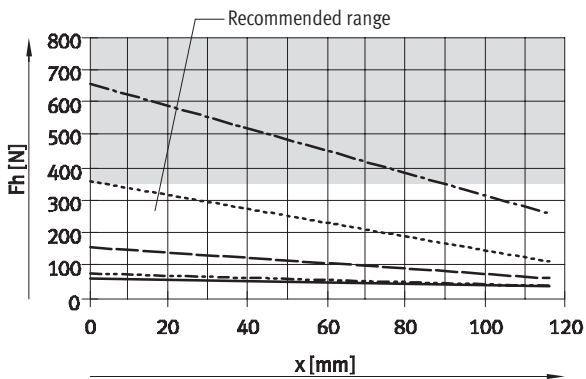

closing

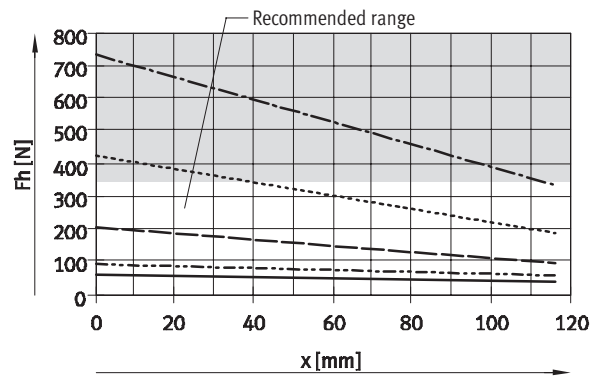

- $v = 2 \text{ mm/s}$ - - - - - $v = 40 \text{ mm/s}$
- - - - - $v = 10 \text{ mm/s}$ - · - · - $v = 60 \text{ mm/s}$
- · - · - $v = 20 \text{ mm/s}$

Total gripping force F with a lever arm $x = 20 \text{ mm}$

Travel speed v	[mm/s]	2	5	10	20	40	60
opening	[N]	120	120	148	293	652	1,150
closing	[N]	121	120	176	376	771	1,300

Parallel grippers HGPLE, sturdy with long stroke, electric

Technical data

Characteristic load values at the gripper jaws

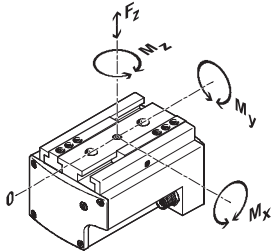

The indicated permissible forces and torques apply to a single gripper jaw. They include the lever arm, additional applied loads due to the workpiece or external gripper fingers and acceleration forces occurring during movement.

The zero coordinate line (guide groove of the gripper jaws) must be taken into consideration for the calculation of torques.

Size		25
Max. permissible force F_z	[N]	1,500
Max. permissible torque M_x	[Nm]	100
Max. permissible torque M_y	[Nm]	60
Max. permissible torque M_z	[Nm]	70

Mass moment of inertia [kgcm²]

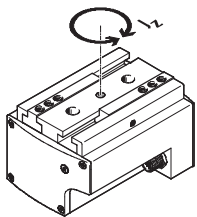

- Under the following conditions:
- The reference point is the central axis
 - Without external gripper fingers
 - In a load-free state

Size		25
Mass moment of inertia J_z	[kgcm ²]	28.32

Positioning time t as a function of stroke per gripper jaw l and travel speed v

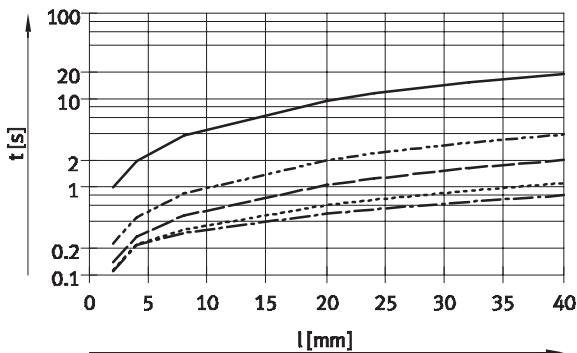

- $v = 2 \text{ mm/s}$
- - - $v = 10 \text{ mm/s}$
- · - $v = 20 \text{ mm/s}$
- · · $v = 40 \text{ mm/s}$
- - - $v = 65 \text{ mm/s}$

Parallel grippers HGPLE, sturdy with long stroke, electric

Technical data

Gripping force F_{Grip} per gripper jaw as a function of lever arm x and eccentricity y

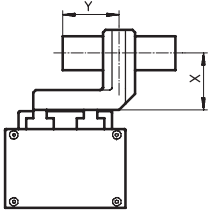

The gripping forces as a function of eccentric application of force and the maximum permissible off-centre point at which force is applied can be determined from the following graphs.

Calculation example

Given:

Lever arm $x = 60$ mm

Eccentricity $y = 70$ mm

To be calculated:

Gripping force at $v < 1$ mm/s

Procedure:

- Determine the intersection xy between the lever arm x and eccentricity y in the graph for HGPLE
- Draw an arc (with centre at origin) through the intersection xy
- Determine the intersection between the arc and X axis
- Read the gripping force

Result:

Gripping force = approx. 44 N

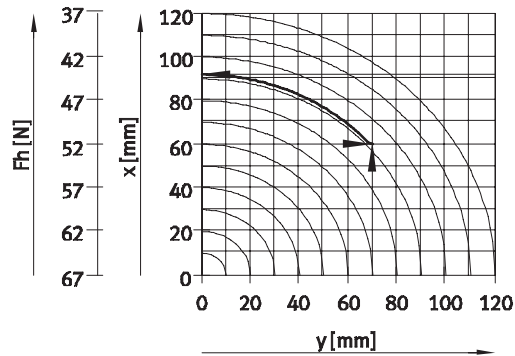

External gripping (closing)

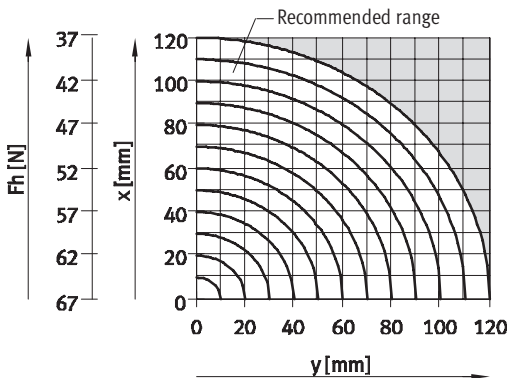

Internal gripping (opening)

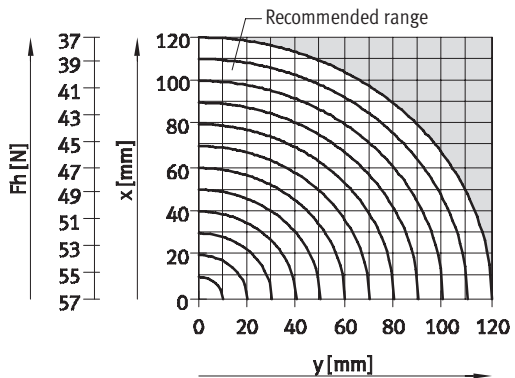

Pin allocation of connecting plug

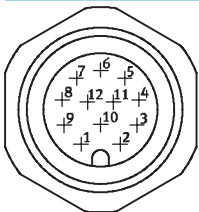

Plug M12		
Pin	Connection	Function
1	Motor +	Motor conductor
2	Motor -	Motor conductor
3	A	Encoder signal RS 485
4	A/	Encoder signal RS 485
5	B	Encoder signal RS 485
6	B/	Encoder signal RS 485
7	I	Encoder signal RS 485
8	I/	Encoder signal RS 485
9	+5 V DC	Signal supply
10	0 V	Signal ground
11	-	Preassigned
12	-	Preassigned

Parallel grippers HGPLE, sturdy with long stroke, electric

Technical data

FESTO

Dimensions

Download CAD data → www.festo.com

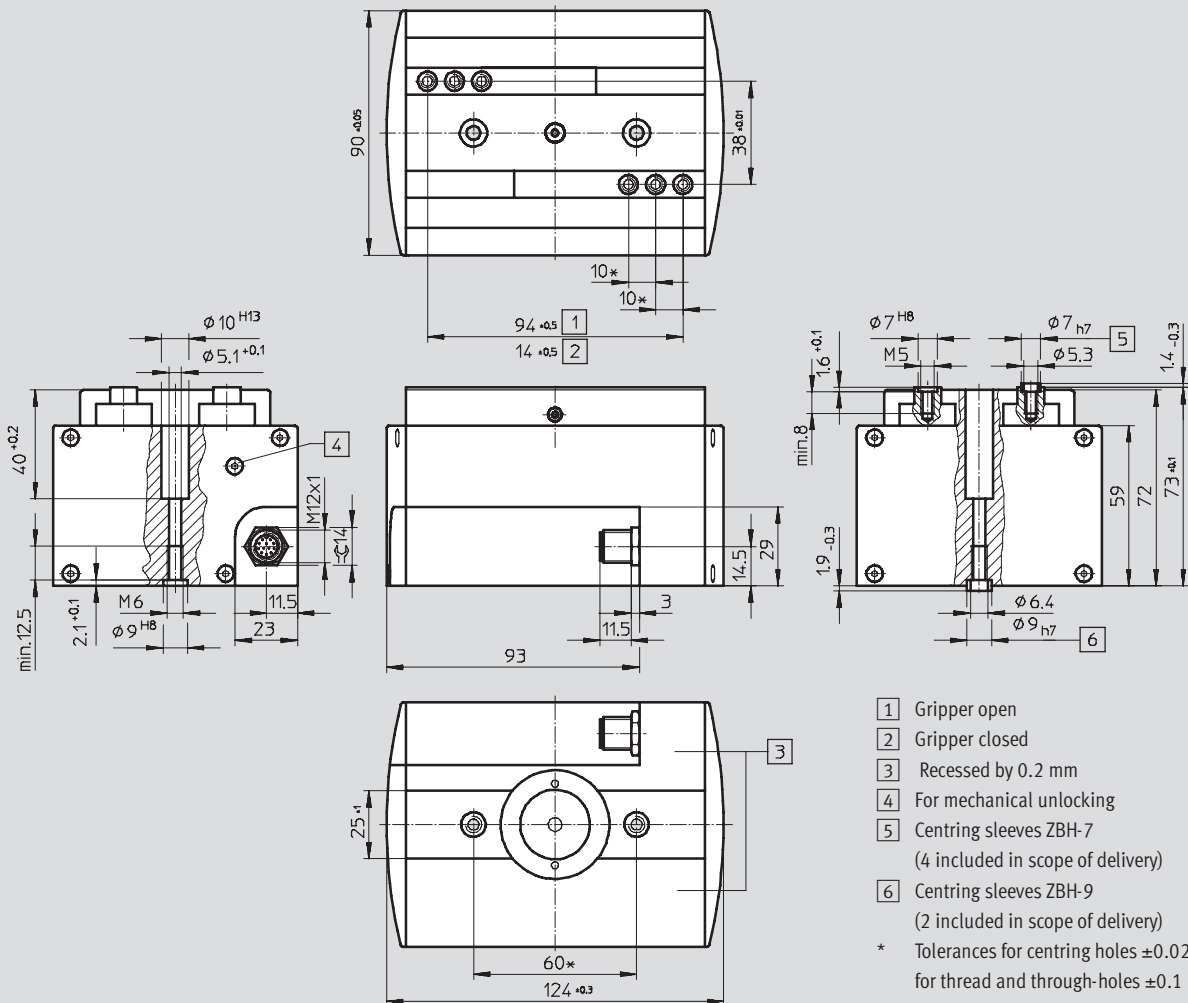

Ordering data

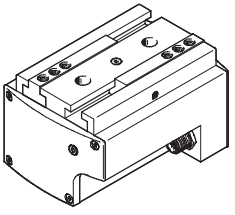
	Part No.	Type
	555563	HGPLE-25-40-2,8-DC-VCSC-G85

Parallel grippers HGPLE, sturdy with long stroke, electric

Accessories

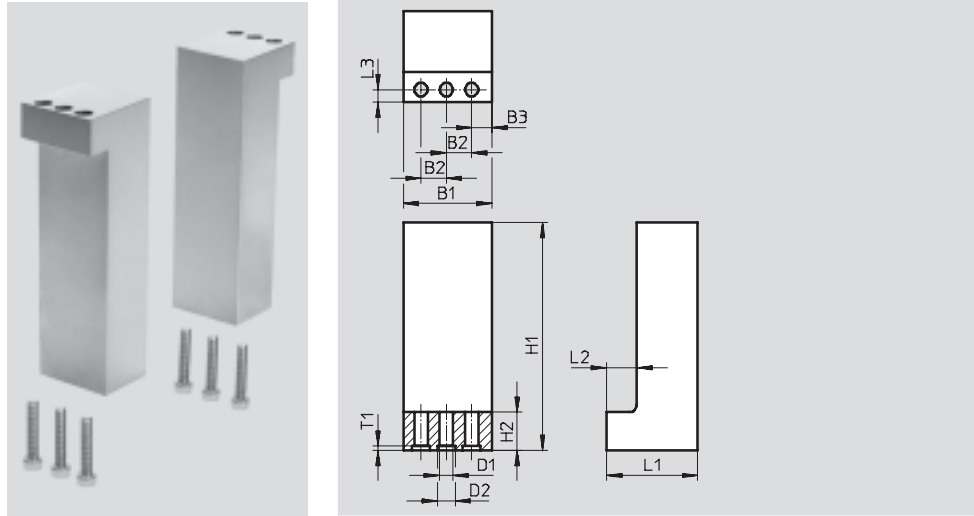

Gripper jaw blank BUB-HGPL
(scope of delivery: 2 pieces)

Material:
Aluminium
Free of copper, PTFE and silicone



Dimensions and ordering data						
B1	B2	B3	D1	D2	H1	H2
±0.1	+0.02		∅ +0.1	∅ H8	∅ ±0.1	
35	10	8	5.3	7	120	15

L1	L2	L3	T1	Weight per blank	Part No.	Type
±0.1	+0.1	+0.1	+0.1	[g]		
36	12	5	1.6	295	537317	BUB-HGPL-25

Ordering data						
	Weight [g]		Part No.	Type		PU ¹⁾
Centring sleeve for the gripper jaws ZBH Technical data → Internet: zbh						
	1		186717	ZBH-7		10
Centring sleeve for the gripper ZBH Technical data → Internet: zbh						
	1		150927	ZBH-9		10

1) Packaging unit quantity

Product Range and Company Overview

A Complete Suite of Automation Services

Our experienced engineers provide complete support at every stage of your development process, including: conceptualization, analysis, engineering, design, assembly, documentation, validation, and production.



Custom Automation Components
Complete custom engineered solutions



Custom Control Cabinets
Comprehensive engineering support and on-site services



Complete Systems
Shipment, stocking and storage services

The Broadest Range of Automation Components

With a comprehensive line of more than 30,000 automation components, Festo is capable of solving the most complex automation requirements.



Electromechanical
Electromechanical actuators, motors, controllers & drives



Pneumatics
Pneumatic linear and rotary actuators, valves, and air supply



PLCs and I/O Devices
PLC's, operator interfaces, sensors and I/O devices

Supporting Advanced Automation... As No One Else Can!

Festo is a leading global manufacturer of pneumatic and electromechanical systems, components and controls for industrial automation, with more than 12,000 employees in 56 national headquarters serving more than 180 countries. For more than 80 years, Festo has continuously elevated the state of manufacturing with innovations and optimized motion control solutions that deliver higher performing, more profitable automated manufacturing and processing equipment. Our dedication to the advancement of automation extends beyond technology to the education and development of current and future automation and robotics designers with simulation tools, teaching programs, and on-site services.

Quality Assurance, ISO 9001 and ISO 14001 Certifications

Festo Corporation is committed to supply all Festo products and services that will meet or exceed our customers' requirements in product quality, delivery, customer service and satisfaction.

To meet this commitment, we strive to ensure a consistent, integrated, and systematic approach to management that will meet or exceed the requirements of the ISO 9001 standard for Quality Management and the ISO 14001 standard for Environmental Management.



© Copyright 2008, Festo Corporation. While every effort is made to ensure that all dimensions and specifications are correct, Festo cannot guarantee that publications are completely free of any error, in particular typing or printing errors. Accordingly, Festo cannot be held responsible for the same. For Liability and Warranty conditions, refer to our "Terms and Conditions of Sale", available from your local Festo office. All rights reserved. No part of this publication may be reproduced, distributed, or transmitted in any form or by any means, electronic, mechanical, photocopying or otherwise, without the prior written permission of Festo. All technical data subject to change according to technical update.



Printed on recycled paper at New Horizon Graphic, Inc., FSC certified as an environmentally friendly printing plant.

Festo North America

United States

Customer Resource Center

502 Earth City Expy., Suite 125
Earth City, MO 63045

For ordering assistance, or to find
your nearest Festo Distributor,

Call: 1.800.99.FESTO

Fax: 1.800.96.FESTO

Email: customer.service@us.festo.com

For technical support,

Call: 1.866.GO.FESTO

Fax: 1.800.96.FESTO

Email: product.support@us.festo.com

Headquarters

Festo Corporation
395 Moreland Road
P.O. Box 18023
Hauppauge, NY 11788
www.festo.com/us

Sales Offices

Appleton

N. 922 Tower View Drive, Suite N
Greenville, WI 54942

Boston

120 Presidential Way, Suite 330
Woburn, MA 01801

Chicago

1441 East Business Center Drive
Mt. Prospect, IL 60056

Dallas

1825 Lakeway Drive, Suite 600
Lewisville, TX 75057

Detroit - Automotive Engineering Center

2601 Cambridge Court, Suite 320
Auburn Hills, MI 48326

New York

395 Moreland Road
Hauppauge, NY 11788

Silicon Valley

4935 Southfront Road, Suite F
Livermore, CA 94550

Design and Manufacturing Operations



East: 395 Moreland Road, Hauppauge, NY 11788



Central: 1441 East Business Center Drive, Mt. Prospect, IL 60056



West: 4935 Southfront Road, Suite F, Livermore, CA 94550

Mexico

Headquarters

Festo Pneumatic, S.A.
Av. Ceylán 3, Col. Tequesquahuac
54020 Tlalnepantla, Edo. de México
Call: 011 52 [55] 53 21 66 00
Fax: 011 52 [55] 53 21 66 65
Email: festo.mexico@mx.festo.com
www.festo.com/mx



Canada

Headquarters

Festo Inc.
5300 Explorer Drive
Mississauga, Ontario L4W 5G4
Call: 1.905.624.9000
Fax: 1.905.624.9001
Email: info.ca@ca.festo.com
www.festo.com/ca



Festo Worldwide

Argentina Australia Austria Belarus Belgium Brazil Bulgaria Canada Chile China Colombia Croatia Czech Republic Denmark
Estonia Finland France Germany Great Britain Greece Hong Kong Hungary India Indonesia Iran Ireland Israel Italy Japan
Latvia Lithuania Malaysia Mexico Netherlands New Zealand Norway Peru Philippines Poland Romania Russia Serbia Singapore
Slovakia Slovenia South Africa South Korea Spain Sweden Switzerland Taiwan Thailand Turkey Ukraine United States Venezuela

www.festo.com