

Three-point gripper DHDS

FESTO



Characteristics

At a glance

General

- Heavy-duty, precision T-slot guide for gripper jaws
- High gripping forces with compact dimensions
- Options for centring the gripper jaws
- Max. repetition accuracy
- Gripping force backup
- Internal fixed flow control
- Wide range of adaptation options on the drives
- Sensor technology:
 - Adaptable position sensor for the small gripper sizes
 - Integratable proximity switches for the medium and large gripper sizes

Flexible range of applications

- Can be used as a double-acting and single-acting gripper
- Compression spring for supporting or backing up the gripping forces
- Suitable for external and internal gripping

The technology in detail

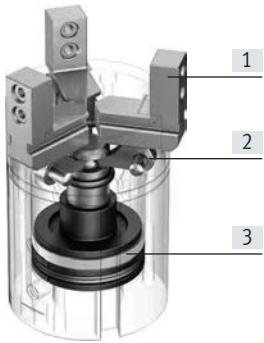

- [1] Gripper jaws
- [2] Reversing lever
- [3] Piston with magnet

Note

Engineering software
Gripper selection
→ www.festo.com

Position sensing/force control

With position transmitter SMAT-8M



- Analogue position feedback possible
- Analogue output 0 ... 10 V

With proportional-pressure regulator VPPM



- Infinite adjustment of the gripping force possible
- Setpoint value input
 - 0 ... 10 V
 - 4 ... 20 mA

With proximity switch SMT-8G



- Detecting multiple positions:
- Open
 - Closed
 - Workpiece gripped

Key features

Compressed air supply ports

From the side

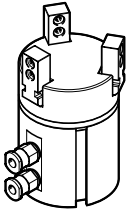

Mounting options

Size 16

Size 32, 50

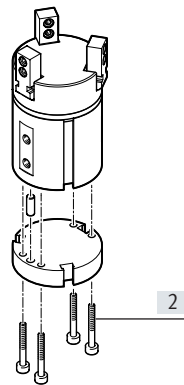
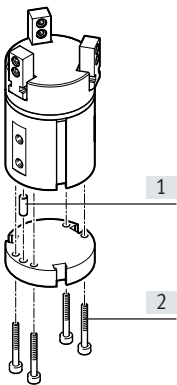

- [1] Centring pin
- [2] Retaining screws

Mounting options for external gripper fingers

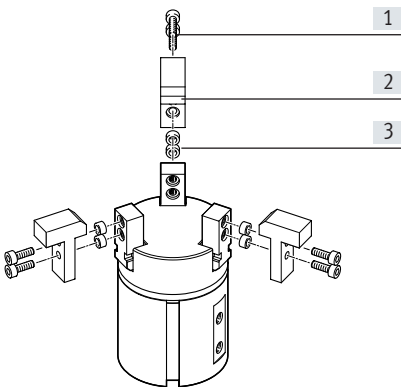

- [1] Retaining screws
- [2] Gripper finger
- [3] Centring sleeves

Note

These grippers are not designed for the following or similar applications:

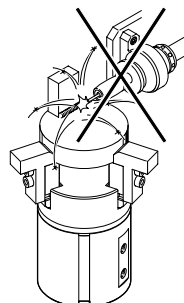

- Welding spatter

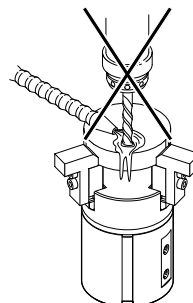

- Machining
- Aggressive media

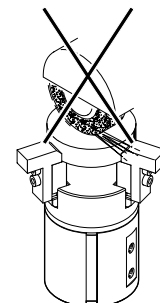

- Grinding dust

Peripherals overview

Peripherals overview

DHDS-16

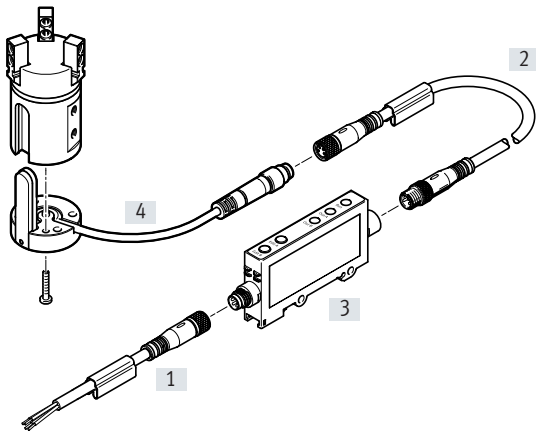

DHDS-32, 50

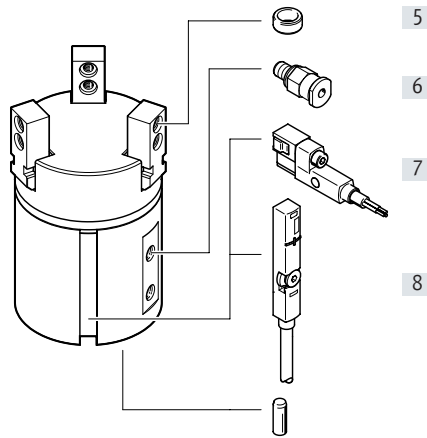

System product for handling and assembly technology

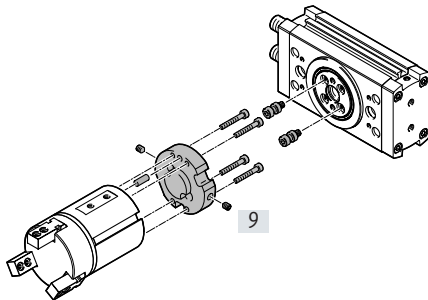

Proportional-pressure regulator VPPM

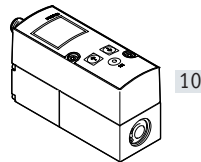

Accessories

Type	Size	Description	→ Page/Internet
[1] Connecting cable NEBU	16	• Connection between signal converter and controller	16
[2] Connecting cable NEBU	16	• Connection between position sensor and signal converter	16
[3] Signal converter SVE4	16	• For evaluating signals for position sensor SMH-S1	16
[4] Position sensor SMH-S1	16	• Adaptable and integratable sensor technology, for sensing the piston position	16
[5] Centring sleeve ZBH	16 ... 50	• For centring the gripper fingers on the gripper jaws • 6 centring sleeves included in the scope of delivery of the gripper	16
[6] Push-in fitting QS	16 ... 50	• For connecting tubing with standard outside diameters	qs
[7] Proximity switch SMT-8G	32, 50	• For sensing the piston position • Proximity switch does not project past the housing at the bottom	17
[8] Position transmitter SMAT-8M	32, 50	• Continuously senses the position of the piston. It has an analogue output and an output signal relative to the piston position.	17
[9] Adapter kit DHAA, HMSV, HAPG, HMVA	16 ... 50	• Connecting plate between drive and gripper	14
[10] Proportional-pressure regulator VPPM	16 ... 50	• For infinite adjustment of the gripping force	vppm

Type codes

001	Series
DHDS	Three-point gripper

002	Size
16	16
32	32
50	50

003	Position sensing
A	For proximity sensor

004	Gripping force backup
	None
NC	N/O contact

Three-point gripper DHDS

Data sheet

Function
Double-acting
DHDS-...-A

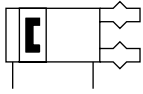

Size
16 ... 50 mm

Stroke
2.5 ... 6 mm

 www.festo.com

Function – Variant
Single-acting or with closing gripping
force backup
DHDS-...-NC



General technical data			
Size	16	32	50
Design	Lever		
	Guided motion sequence		
Mode of operation	Double-acting		
Gripper function	3-point		
Gripping force backup	NC	NC	NC
Number of gripper jaws	3		
Max. load per gripper finger ¹⁾	[g] 50	150	250
Stroke per gripper jaw	[mm] 2.5	3.9	6
Pneumatic connection	M3	M5	G1/8
Repetition accuracy ²⁾	[mm] ≤ 0.04		
Max. interchangeability	[mm] ≤ ±0.2		
Max. operating frequency	[Hz] ≤ 4		
Rotational symmetry	[mm] < ∅ 0.2		
Position sensing	Via position sensor		Via proximity switch, position transmitter
Type of mounting	With female thread and dowel pin		
Mounting position	Any		

- 1) Applies to unthrottled operation
2) Under constant exposure to operating conditions, end-position drift occurs, concentric to the central shaft, at 100 consecutive strokes

Operating and environmental conditions		
Min. operating pressure		
DHDS-...-A	[bar]	2
DHDS-...-A-NC	[bar]	4
Max. operating pressure	[bar]	8
Operating medium	Compressed air to ISO 8573-1:2010 [7:4:4]	
Note on operating/pilot medium	Lubricated operation possible (in which case lubricated operation will always be required)	
Ambient temperature ¹⁾	[°C]	+5 ... +60
Corrosion resistance CRC ²⁾		1

- 1) Note operating range of proximity switches
2) Corrosion resistance class CRC 1 to Festo standard FN 940070
Low corrosion stress. Dry internal application or transport and storage protection. Also applies to parts behind covers, in the non-visible interior area, and parts which are covered in the application (e. g. drive trunnions).

Weight [g]			
Size	16	32	50
DHDS-...-A	96	276	920
DHDS-...-A-NC	99	281	932

Data sheet

Materials

Sectional view

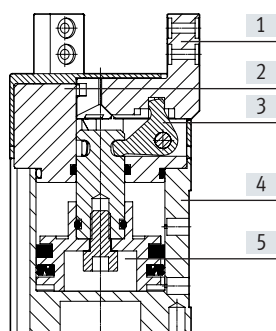

Three-point gripper		
[1]	Gripper jaws	High-alloy stainless steel
[2]	Cover cap	Polyamide
[3]	Reversing lever	Hardened sintered steel
[4]	Housing	Hard anodised wrought aluminium alloy
[5]	Piston	Polyacetal
-	Note on materials	Free of copper and PTFE RoHS-compliant

Gripping force [N] at 6 bar

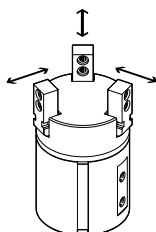

Size	16	32	50	
Gripping force per gripper jaw				
DHDS-...-A	Opening	40	135	280
	Closing	29	115	250
Total gripping force				
DHDS-...-A	Opening	120	405	840
	Closing	87	345	750

Characteristic load values at the gripper jaws

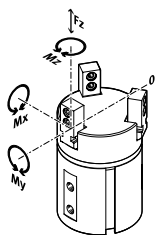

The indicated permissible forces and torques apply to a single gripper jaw. They include the lever arm, additional weight forces created by the workpiece or external gripper fingers and acceleration forces during movement. The zero coordinate line (gripper-jaw point of rotation) must be taken into consideration for the calculation of torques.

Size	16	32	50	
Max. permissible force F_z	[N]	50	150	250
Max. permissible torque M_x	[Nm]	2	9	24
Max. permissible torque M_y	[Nm]	2	9	24
Max. permissible torque M_z	[Nm]	2	9	24

Data sheet

Mass moment of inertia [kgcm²]

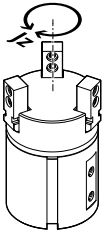

Mass moment of inertia of the three-point gripper in relation to the central axis, without external gripper fingers, without load.

Size	16	32	50
DHDS-...	0.14	0.79	6.10
DHDS-...-NC	0.14	0.82	6.18

Gripper jaw backlash

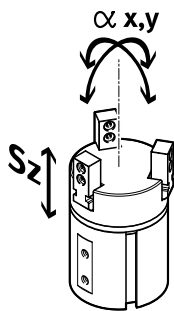

The plain-bearing guide used in the grippers means that there is backlash between the gripper jaws and the housing. The backlash values entered in the table have been calculated in accordance with the traditional accumulative tolerance method.

Size	16	32	50
Max. gripper jaw backlash Sz [mm]	≤ 0.02		
Max. gripper jaw angular backlash ax, ay [°]	≤ 0.5	≤ 0.2	

Opening and closing times [ms] at 6 bar

Without external gripper fingers

With external gripper fingers

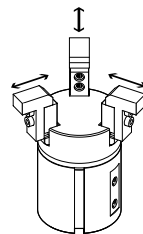
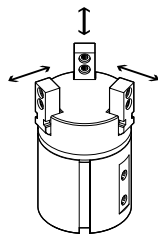

The opening and closing times [ms] were measured at room temperature at an operating pressure of 6 bar with the gripper horizontally mounted and without additional gripper fingers. The grippers must be throttled for larger loads [g]. Opening and closing times must then be adjusted accordingly.

Size	16	32	50	
Without external gripper fingers				
DHDS-...-A	Opening	26	44	62
	Closing	42	51	55
DHDS-...-A-NC	Opening	31	55	73
	Closing	34	47	50
With external gripper fingers (as a function of load per gripper finger)				
DHDS-...	100 g	100	-	-
	200 g	-	100	-
	300 g	-	200	100
	400 g	-	-	200
	500 g	-	-	300

Data sheet

Gripping force F_H per gripper jaw as a function of operating pressure and lever arm x

The gripping forces as a function of the operating pressure and lever arm can be determined from the following graphs.

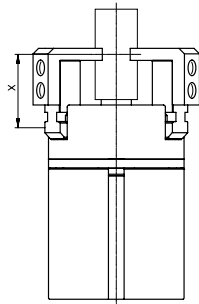

Note
 Engineering software
 Gripper selection
 → www.festo.com

External gripping (closing)

DHDS-16-A

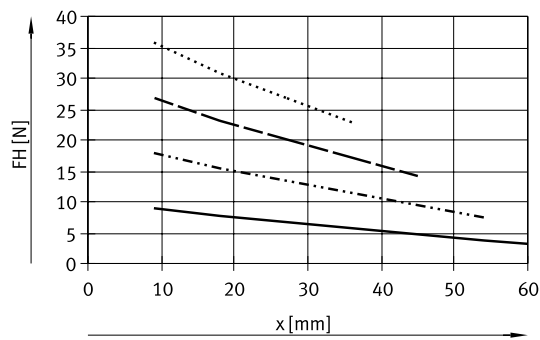

DHDS-32-A

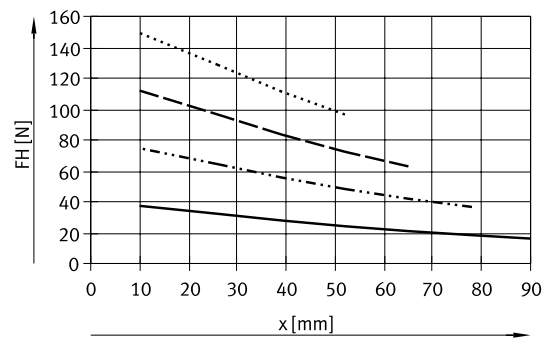

DHDS-50-A

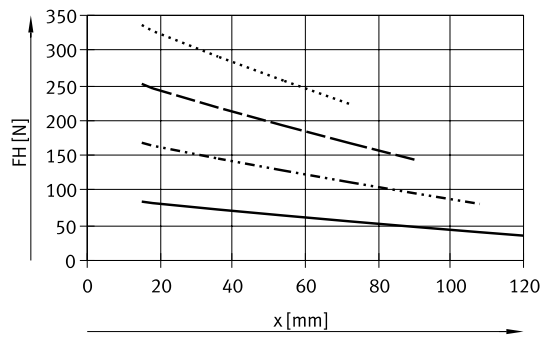

- 2 bar
- 4 bar
- - - 6 bar
- · - · 8 bar

Data sheet

Gripping force F_H per gripper jaw as a function of operating pressure and lever arm x

The gripping forces as a function of the operating pressure and lever arm can be determined from the following graphs.

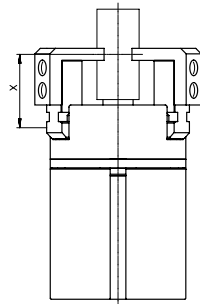

Note
 Engineering software
 Gripper selection
 → www.festo.com

Internal gripping (opening)

DHDS-16-A

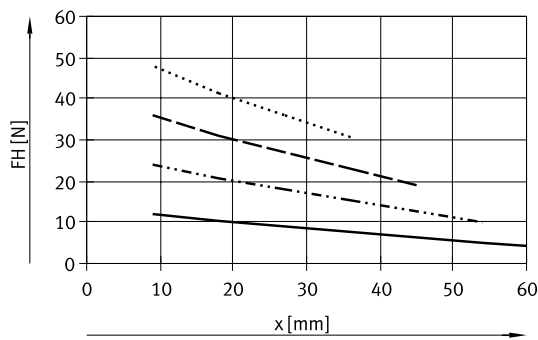

DHDS-32-A

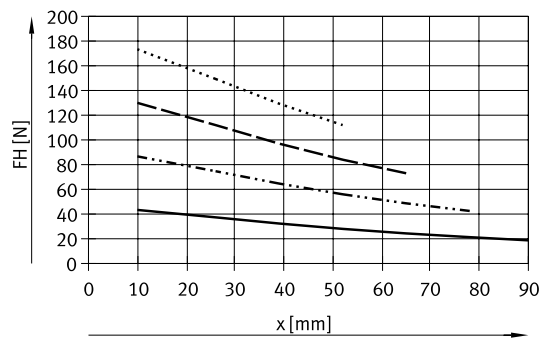

DHDS-50-A

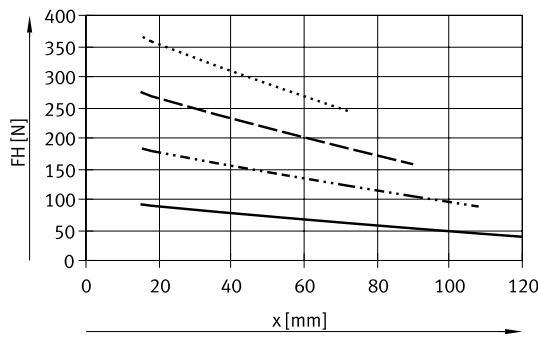

- 2 bar
- 4 bar
- - - 6 bar
- · - · 8 bar

Data sheet

Spring force F_F as a function of size and gripper jaw stroke l

Gripping force backup for DHDS-...-NC

The spring forces F_F as a function of the gripper jaw stroke can be determined from the following graph.

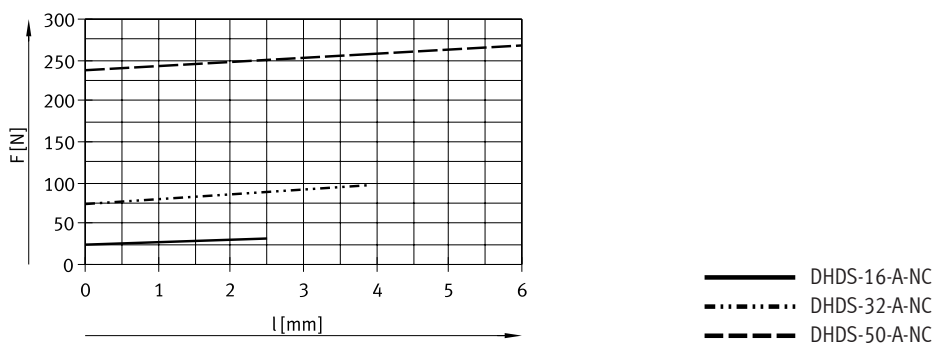
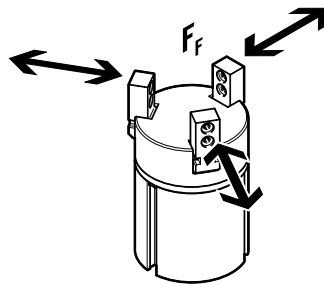

Spring force F_F as a function of size, gripper jaw stroke l and lever arm x per gripper finger

The lever arm x must be taken into consideration when determining the actual spring force F_{total} .

The formulae for calculating the spring force are provided in the table below.

Gripping force backup	Size	F_{total} per gripper finger
NC	16	$-0.1 \cdot x + 0.33 \cdot F_F$
	32	$-0.2 \cdot x + 0.33 \cdot F_F$
	50	$-0.3 \cdot x + 0.33 \cdot F_F$

Determining the actual gripping forces F_{Gr} for DHDS-...-NC as a function of application per gripper finger

Depending on requirement, the three-point grippers with integrated spring, type DHDS-...-NC (closing gripping force backup), can be used as:

- single-acting grippers
- grippers with supplementary gripping force and
- grippers with gripping force backup

In order to calculate the available gripping forces F_{Gr} (per gripper finger), the gripping force F_H and spring force F_{total} must be combined accordingly.

Application forces per gripper finger

Single-acting	Supplementary gripping force	Gripping force backup
<ul style="list-style-type: none"> • Gripping with spring force: $F_{\text{Gr}} = F_{\text{total}}$ • Gripping with pressure force: $F_{\text{Gr}} = F_H - F_{\text{total}}$ 	<ul style="list-style-type: none"> • Gripping with pressure and spring force: $F_{\text{Gr}} = F_H + F_{\text{total}}$ 	<ul style="list-style-type: none"> • Gripping with spring force: $F_{\text{Gr}} = F_{\text{total}}$

Data sheet

Dimensions

Download CAD data → www.festo.com

DHDS-16

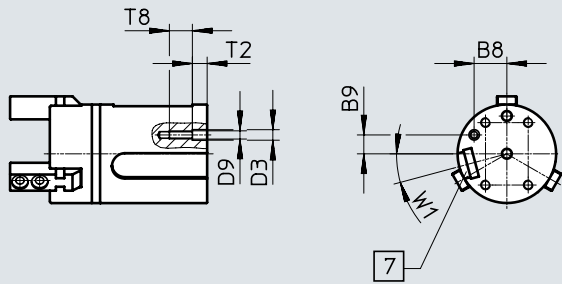

DHDS-32/50

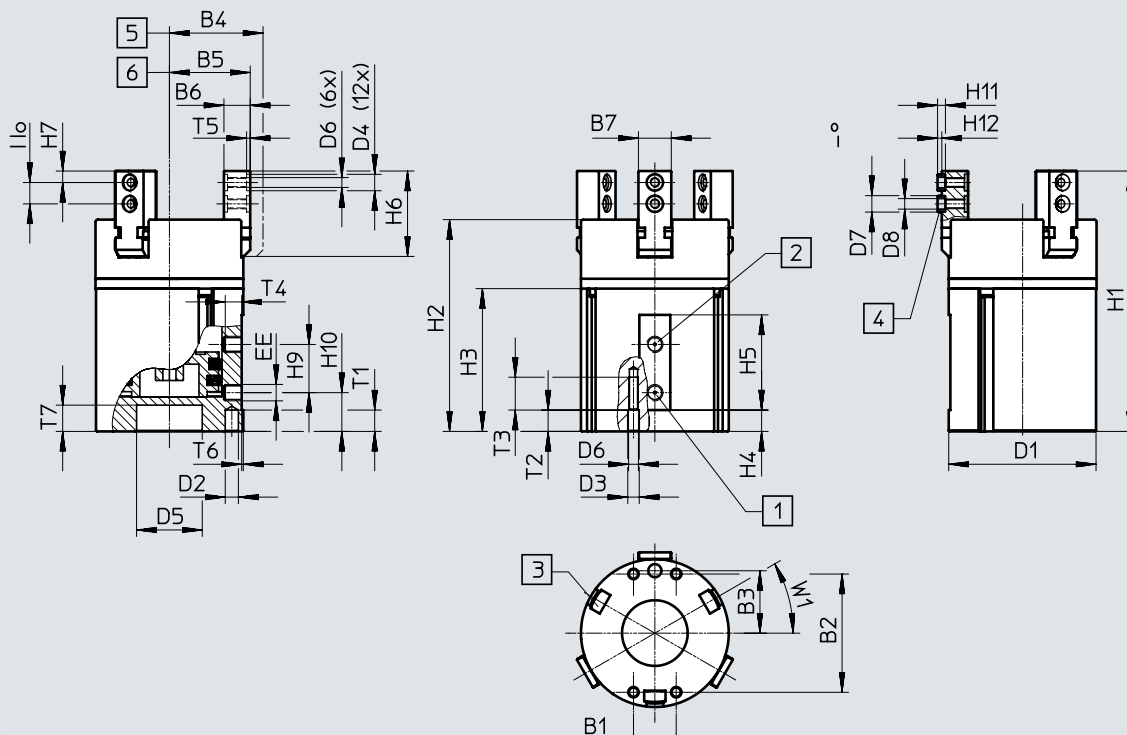

- [1] Supply port, opening
- [2] Supply port, closing
- [3] Slot for proximity switch
- [4] Centring sleeve ZBH (6 included in the scope of delivery)
- [5] Gripper jaws open
- [6] Gripper jaws closed
- [7] Slot for position sensor

Data sheet

Size	B1	B2	B3	B4	B5	B6	B7	B8	B9
[mm]			±0.02	±0.5	±0.5	-0.02/-0.05	-0.02	-0.1	-0.1
16	13	19	11.5	20	17.5	7	6	9.96	5.75
32	13	36	19	28.5	24.6	8	10	-	-
50	25	54	30	43	37	12	14	-	-

Size	D1	D2	D3	D4	D5	D6	D7	D8	D9
[mm]	∅	∅	∅	∅	∅		∅	∅	
		H8	H8	H8	+0.05/+0.02		h7		
16	30	3	3.2	5	-	M3	5	3.2	M2.5
32	45	4	3.5	5	20	M3	5	3.2	-
50	70	5	6	7	30	M5	7	5.3	-

Size	EE	H1	H2	H3	H4	H5	H6	H7	H8 ¹⁾	H9
[mm]										
16	M3	60	47.9	32.6	4.5	24	21.5	3	6	12
32	M5	78	63.2	42.2	5.2	29	26	3.5	6.5	14.7
50	G1/8	107.5	86.5	56	6.7	40	37	5	10	22

Size	H10	T1	T2	T3	T4	T5	T6	T7	T8	W1
[mm]		min.	min.	+1	-0.5	+0.1	±0.2		±1	
16	11	4.5	4.5	8	4	1.2	1	-	7	15°
32	10.5	6.5	6.5	10	4	1.1	0.5	8	-	30°
50	16	7	7	18	6	1.6	1	9	-	30°

1) Tolerance for centring hole ±0.02 mm; tolerance for thread ±0.1 mm

Ordering data

Size	Double-acting without compression spring		Single-acting or with gripping force backup closing	
	Part no.	Type	Part no.	Type
16	1259491	DHDS-16-A	1259492	DHDS-16-A-NC
32	1259493	DHDS-32-A	1259494	DHDS-32-A-NC
50	1259495	DHDS-50-A	1259496	DHDS-50-A-NC

Accessories

Adapter kit
DHAA, HAPG, HMSV, HMVA

Material:
Wrought aluminium alloy
Free of copper and PTFE
RoHS-compliant

 **Note**
The kit includes the individual mounting interface as well as the necessary mounting material.

Permissible drive/gripper combinations with adapter kit

Download CAD data → www.festo.com

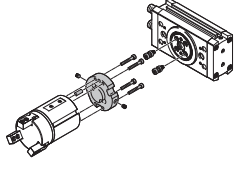
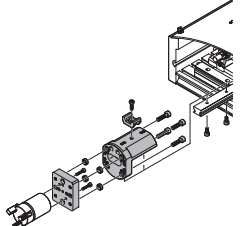
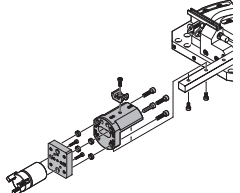
Combination	Actuator Size	Gripper Size	Adapter kit		
			KBK ¹⁾	Part no.	Type
	DRRD	DHDS	2	DHAA	
	12	16		2823512	DHAA-G-Q11-12-B4-16
	16	16		2136626	DHAA-G-Q11-16-B4-16
	16	32		2151381	DHAA-G-Q11-16-B4-32
	20	32		2136339	DHAA-G-Q11-20-B4-32
	25	32		1471583	DHAA-G-Q11-25-B4-32
	25	50		1731165	DHAA-G-Q11-25-B4-50
	32	50		1907040	DHAA-G-Q11-32-B4-50
	35	50	2135899	DHAA-G-Q11-35-B4-50	
	HSP	DHDS	2	HAPG	
	16	16		192705	HAPG-36-S1
				540882	HAPG-71-B
	25	16		192705	HAPG-36-S1
			540883	HAPG-72-B	
	HSW	DHDS	2	HAPG	
	16	16		192705	HAPG-36-S1
				540882	HAPG-71-B

1) Corrosion resistance class CRC 2 to Festo standard FN 940070
Moderate corrosion stress. Indoor applications in which condensation can occur. External visible parts with primarily decorative surface requirements which are in direct contact with a normal industrial environment.

2) For DGEA-... only

Accessories

Adapter kit
DHAA, HAPG

Material:
Wrought aluminium alloy
Free of copper and PTFE
RoHS-compliant

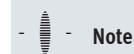

Note

The kit includes the individual mounting interface as well as the necessary mounting material.

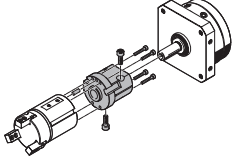
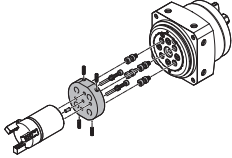
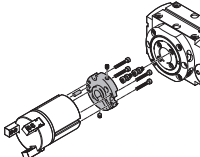
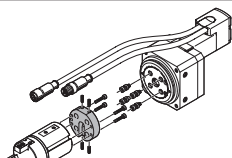
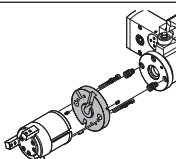
Permissible drive/gripper combinations with adapter kit				Download CAD data → www.festo.com		
Combination	Actuator Size	Gripper Size	Adapter kit			
			KBK ¹⁾	Part no.	Type	
	DSM	DHDS	HAPG			
	8, 10	16	2	187569	HAPG-35	
	25	32		163272	HAPG-23	
	DSM...-HD	DHDS	DHAA			
	12	16	2	8072232	DHAA-G-R3-12-B19-16	
	16	16		8079175	DHAA-G-R3-16-B19-16	
	16	32		8079191	DHAA-G-R3-16-B19-32	
	25	32		8079196	DHAA-G-R3-25-B19-32	
	25	50		8079199	DHAA-G-R3-25-B19-50	
	32	50		8079210	DHAA-G-R3-32-B19-50	
	ERMB	DHDS		HAPG		
	20	32	2	184481	HAPG-SD2-5	
	25	50		184484	HAPG-SD2-8	
	32	50		184487	HAPG-SD2-11	
	ERMO	DHDS	DHAA			
	12	16	2	8072232	DHAA-G-R3-12-B19-16	
	16	16		8079175	DHAA-G-R3-16-B19-16	
	16	32		8079191	DHAA-G-R3-16-B19-32	
	25	32		8079196	DHAA-G-R3-25-B19-32	
	25	50		8079199	DHAA-G-R3-25-B19-50	
	32	50		8079210	DHAA-G-R3-32-B19-50	
	EHMB	DHDS		HAPG		
	20	50	2	184487	HAPG-SD2-11	
	25, 32	50		526026	HAPG-SD2-20	

1) Corrosion resistance class CRC 2 to Festo standard FN 940070

Moderate corrosion stress. Indoor applications in which condensation can occur. External visible parts with primarily decorative surface requirements which are in direct contact with a normal industrial environment.

Accessories

Ordering data		For size [mm]	Comment	Weight [g]	Part no.	Type	PU ¹⁾
Centring sleeve ZBH				Data sheets → Internet: zbh			
	16, 32	For centring the gripper fingers on the gripper jaws	1	189652	ZBH-5	10	
	50		1	186717	ZBH-7		

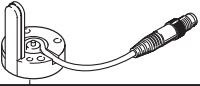

1) Packaging unit

Ordering data		For size	Weight [g]	Part no.	Type
Position sensor SMH-S1		Data sheets → Internet: smh-s1			
	16	30	175713	SMH-S1-HGD16	

Signal converter SVE4 for position sensor SMH-S1

- Converts analogue signals into switching points
- Switching function freely programmable with teach-in
- Threshold value, hysteresis or window comparator

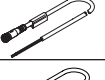
Ordering data		For size	Input connection	Output connection	Switching output	Weight [g]	Part no.	Type
Signal converter SVE4		Data sheets → Internet: sve4						
	16	Socket M8x1, 4-pin	Plug M8x1, 4-pin	2x PNP	19	544216	SVE4-HS-R-HM8-2P-M8	
				2x NPN		544219	SVE4-HS-R-HM8-2N-M8	

Ordering data – Connecting cables		Electrical connection, left	Electrical connection, right	Cable length [m]	Part no.	Type
Connection between position sensor and signal converter						
	Straight socket, M8x1, 4-pin	Straight plug M8x1, 4-pin	2.5	554035	NEBU-M8G4-K-2.5-M8G4	
Connection between signal converter and controller						
	Straight socket, M8x1, 4-pin	Cable, open end, 4-wire	2.5	541342	NEBU-M8G4-K-2.5-LE4	
			5	541343	NEBU-M8G4-K-5-LE4	
	Angled socket, M8x1, 4-pin	Cable, open end, 4-wire	2.5	541344	NEBU-M8W4-K-2.5-LE4	
			5	541345	NEBU-M8W4-K-5-LE4	

Accessories

Proximity switch for size 32, 50



Ordering data – Proximity switch for T-slot, magneto-resistive

Data sheets → Internet: smt

	Type of mounting	Electrical connection, outlet direction of connection	Switching output	Cable length [m]	Part no.	Type
N/O contact						
	Inserted in the slot lengthwise	Cable, 3-wire, crosswise	PNP	2.5	547859	SMT-8G-PS-24V-E-2,5Q-OE
		Plug M8x1, 3-pin, crosswise		0.3	547860	SMT-8G-PS-24V-E-0,3Q-M8D
		Cable, 3-wire, crosswise	NPN	2.5	8065028	SMT-8G-NS-24V-E-2,5Q-OE
		Plug M8x1, 3-pin, crosswise		0.3	8065027	SMT-8G-NS-24V-E-0,3Q-M8D

Ordering data – Connecting cables

Data sheets → Internet: nebu

	Electrical connection, left	Electrical connection, right	Cable length [m]	Part no.	Type
	Straight socket, M8x1, 3-pin	Cable, open end, 3-wire	2.5	541333	NEBU-M8G3-K-2.5-LE3
			5	541334	NEBU-M8G3-K-5-LE3
	Angled socket, M8x1, 3-pin	Cable, open end, 3-wire	2.5	541338	NEBU-M8W3-K-2.5-LE3
			5	541341	NEBU-M8W3-K-5-LE3

Position transmitter

The position transmitter continuously senses the position of the piston.

It has an analogue output and an output signal relative to the piston position.

Ordering data – Position transmitter for T-slot

Data sheets → Internet: position transmitter

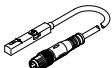
	For size	Position measuring range	Analogue output [V]	Type of mounting	Electrical connection	Cable length [m]	Part no.	Type
	32, 50	0 ... 40	0 ... 10	Inserted in the slot from above	Plug M8x1, 4-pin, in-line	0.3	553744	SMAT-8M-U-E-0,3-M8D

Ordering data – Connecting cables

Data sheets → Internet: nebu

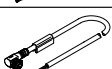
	Electrical connection, left	Electrical connection, right	Cable length [m]	Part no.	Type
	Straight socket, M8x1, 4-pin	Cable, open end, 4-wire	2.5	541342	NEBU-M8G4-K-2.5-LE4
			5	541343	NEBU-M8G4-K-5-LE4
	Angled socket, M8x1, 4-pin	Cable, open end, 4-wire	2.5	541344	NEBU-M8W4-K-2.5-LE4
			5	541345	NEBU-M8W4-K-5-LE4

Festo - Your Partner in Automation



1 Festo Inc.
5300 Explorer Drive
Mississauga, ON L4W 5G4
Canada

Festo Customer Interaction Center
Tel: 1 877 463 3786
Fax: 1 877 393 3786
Email: customer.service.ca@festo.com



2 Festo Pneumatic
Av. Ceylán 3,
Col. Tequesquináhuac
54020 Tlalnepantla,
Estado de México

Multinational Contact Center
01 800 337 8669
ventas.mexico@festo.com



3 Festo Corporation
1377 Motor Parkway
Suite 310
Islandia, NY 11749

Festo Customer Interaction Center
1 800 993 3786
1 800 963 3786
customer.service.us@festo.com



4 Regional Service Center
7777 Columbia Road
Mason, OH 45040

Connect with us



www.festo.com/socialmedia



www.festo.com

Subject to change