

Mini slides DGSC



# Mini slides DGSC

Key features

## At a glance

### Properties

- Smallest guided slide unit (width 8 mm), therefore high component density possible
- Precision ball bearing cage guide permits accurate linearity/parallelism
- Long service life thanks to housing made from high-alloy steel
- Low break-away pressure and uniform movement thanks to minimal friction from guide and seal
- Contact resistance < 5 Ω
- Quick and easy assembly and commissioning

### Range of applications

- Two variants available to order:
  - Mounting interface on the side, supply ports on the front
  - Mounting interface on the front, supply ports on the side
- Chip picking
- Slide or separating applications
- Pushing or stem applications

## Mounting options

### On the housing

DGSC-6-10-P-L

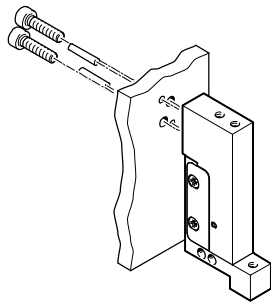

DGSC-6-10-P-P

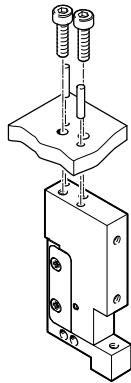

### On the slide

DGSC-6-10-P-...

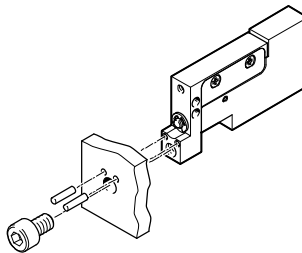

## Pneumatic connection

DGSC-6-10-P-L

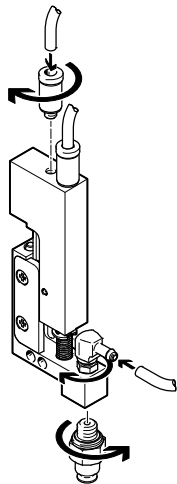

DGSC-6-10-P-P

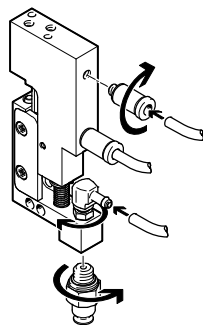

# Mini slides DGSC

Type codes and peripherals overview

## Type codes

		DGSC	-	6	-	10	-	P	-	P
<b>Type</b>										
Double-acting										
DGSC	Mini slide									
<b>Size</b>										
<b>Stroke [mm]</b>										
<b>Cushioning</b>										
P	Elastic cushioning without metal end stop, both ends									
<b>Supply ports</b>										
L	In the direction of movement of the slide									
P	On the side of the housing									

## Overview of peripherals

Supply ports in the direction of movement of the slide

Supply ports on the side of the housing

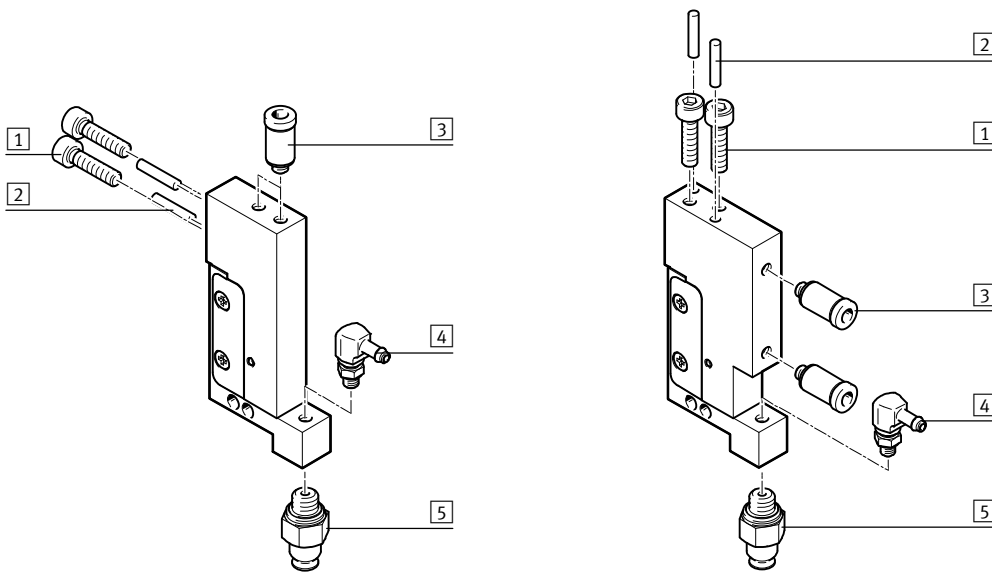

Accessories		Description	→ Page/Internet
1	Screw	For mounting the mini slide	-
2	Centring pin Ø 2, to EN ISO 2338	For centring the mini slide during assembly	-
3	Push-in fitting QSM	For supplying compressed air to the mini slide	8
4	Push-in L-fitting QSML	For connecting vacuum or compressed air to the slide	8
5	Suction cup VAS	-	9

# Mini slides DGSC

Technical data

FESTO

Function

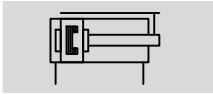

○ - Size  
6

▬ - Stroke length  
10 mm



General technical data		
Size		6
Stroke <sup>1)</sup>	[mm]	10
Pneumatic connection		M3
Design		Scotch yoke system
Guide		Ball bearing cage guide
Type of mounting		Via female thread and dowel pin
Cushioning		Elastic cushioning rings/pads at both ends
Position sensing		None
Mounting position		Any
Max. effective load <sup>2)</sup>	[g]	30
Max. operating frequency	[Hz]	< 4
Contact resistance	[Ω]	< 5
Repetition accuracy	[mm]	±0.1

1) Valid at 6 bar. The complete stroke is not achieved at lower operating pressure due to the integrated cushioning components.

2) For unthrottled operation.

Operating and environmental conditions	
Operating medium	Compressed air in accordance with ISO 8573-1:2010 [7:4:4]
Note on operating/pilot medium	Operation with lubricated medium possible (in which case lubricated operation will always be required)
Operating pressure	[bar] 1 ... 6
Ambient temperature	[°C] 10 ... 50
Corrosion resistance class CRC <sup>1)</sup>	2

1) Corrosion resistance class CRC 2 to Festo standard FN 940070

Moderate corrosion stress. Indoor applications in which condensation may occur. External visible parts with primarily decorative requirements for the surface and which are in direct contact with the ambient atmosphere typical for industrial applications.1

Weight [g]		
Type	DGSC-6-10-P-L	DGSC-6-10-P-P
Product weight	42	52
Moving load	17	17

Forces [N]	
Theoretical force at 6 bar, advance	17
Theoretical force at 6 bar, retract	12.7
Measured force at 6 bar, advance	15.5

Travel times [ms] at 6 bar	
Advancing	19
Retracting	16.5

# Mini slides DGSC

Technical data

## Materials

Sectional view

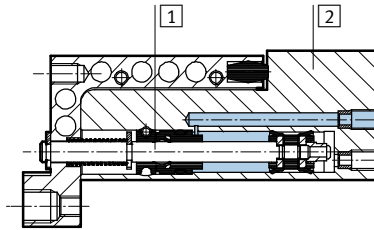

Mini slide

1	Piston rod	High-alloy stainless steel
2	Housing	High-alloy stainless steel
-	Seals	Nitrile rubber
Note on materials		Free of copper and PTFE RoHS-compliant

## Static characteristic load values

The indicated forces and torques refer to the guide.  
These values must not be exceeded during dynamic operation. Special attention must be paid to the cushioning phase.

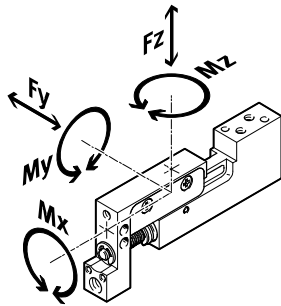

If the drive is simultaneously subjected to several of the indicated forces and torques, the following equation must be satisfied in addition to the indicated maximum loads:

$$\frac{F_y}{F_{y_{max}}} + \frac{F_z}{F_{z_{max}}} + \frac{M_x}{M_{x_{max}}} + \frac{M_y}{M_{y_{max}}} + \frac{M_z}{M_{z_{max}}} \leq 1$$

## Permissible forces and torques

$F_{y_{max}}$	[N]	20
$F_{z_{max}}$	[N]	20
$M_{x_{max}}$	[Nm]	0.3
$M_{y_{max}}$	[Nm]	0.4
$M_{z_{max}}$	[Nm]	0.4

# Mini slides DGSC

Technical data



## Slide displacement at max. stroke

Longitudinal load

Transverse load

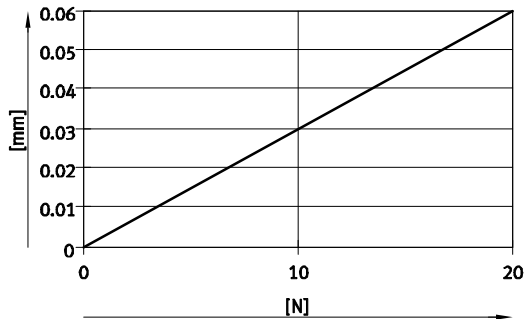
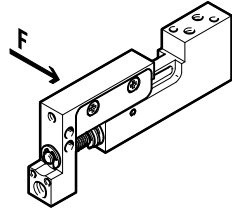
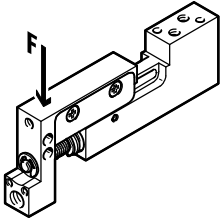

DGSC-6-10-P...

## Stroke compensation

The integrated spring enables stroke compensation of 2.5 mm if there is a risk of collision in the advanced state. Only low spring forces then act on the yoke.

This protects the mechanism from overload.

Stroke:  
L1 = 10 mm

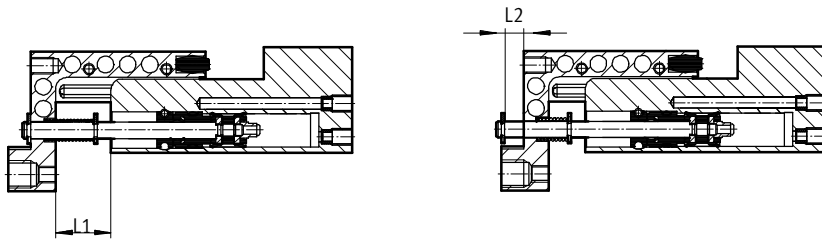

Stroke compensation (L2)	[mm]	0	2.5
Spring force	[N]	2.0	2.4

## Parallelism/perpendicularity/linearity [mm]

### Parallelism/perpendicularity:

Accuracy of alignment between the housing mounting surface and the mounting interface on the yoke.

DGSC-6-10-P-L

DGSC-6-10-P-P

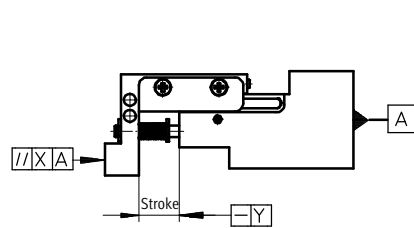
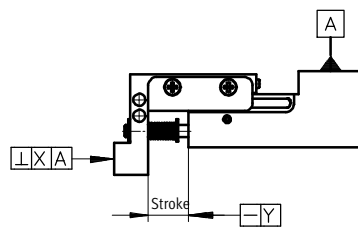

### Linearity:

Maximum distance between individual points on the slide and the housing mounting surface with the drive in retracted and advanced state.

Type		DGSC-6-10-P-L	DGSC-6-10-P-P
Parallelism	[mm]	-	< 0.03
Perpendicularity	[mm]	< 0.03	-
Linearity	[mm]	< 0.01	-

# Mini slides DGSC

Technical data

## Dimensions

Download CAD data → [www.festo.com](http://www.festo.com)

### DGSC-6-10-P-L

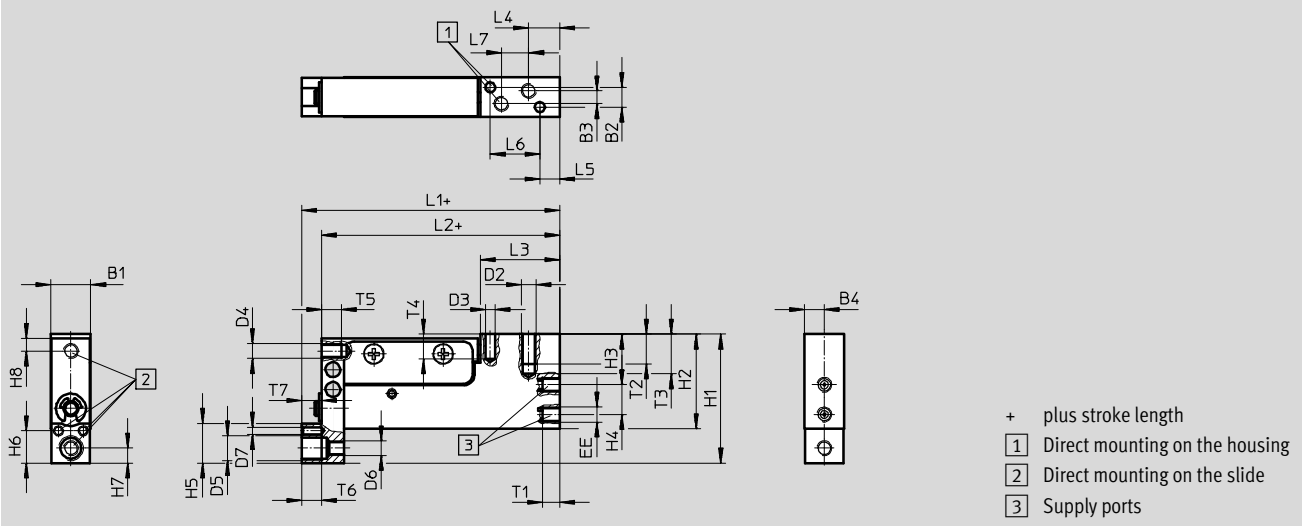

### DGSC-6-10-P-P

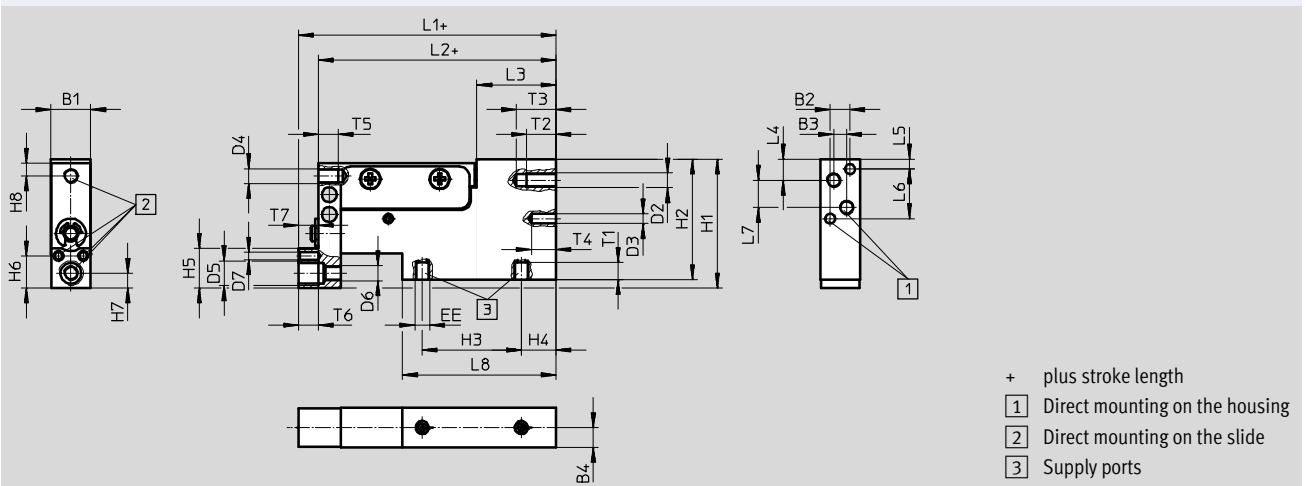

Type	B1	B2	B3	B4	D2	D3	D4	D5	D6	D7	EE
	-0.05/-0.15	±0.02	±0.1			∅ H8				∅ H8	
DGSC-6-10-P-L	8	4	2.6±0.1	4	M3	2	M3	M5	M3	1.5	M3
DGSC-6-10-P-P	8	4	2.6	4	M3	2	M3	M5	M3	1.5	M3

Type	H1	H2	H3	H4	H5	H6	H7	H8	L1	L2	L3
						±0.02					
DGSC-6-10-P-L	26	19.1	10.2	6	8	6.5	3	2.6	52.1	48.1	16.1
DGSC-6-10-P-P	26	24.3	20	7	8	6.5	3	2.6	52	48	16

Type	L4	L5	L6	L7	L8	T1	T2	T3	T4	T5	T6	T7
			±0.02	±0.1		max.	min.	+1	+1	min.	min.	+1
DGSC-6-10-P-L	6.35	4.1	10	5.5	-	3.5	6	8	5	4	4	4
DGSC-6-10-P-P	4.25	2	10	5.5	31	3.5	6	8	5	4	4	4



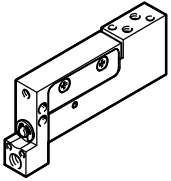

# Mini slides DGSC

Technical data

**FESTO**

Ordering data				
	Type	Brief description	Part No.	Type
	DGSC-6-10-P-L	Supply ports in the direction of movement of the slide	<b>569793</b>	<b>DGSC-6-10-P-L</b>
	DGSC-6-10-P-P	Supply ports on the side of the housing	<b>569792</b>	<b>DGSC-6-10-P-P</b>

## Accessories

Ordering data – Fitting						
Type	Connection		Weight [g]	Part No.	Type	PU <sup>1)</sup>
	Thread	For tubing Ø [mm]				
For supplying compressed air to the mini slide						
Push-in fitting QSM			Technical data → Internet: qsm			
	M3	2 (outside)	0.8	<b>133026</b>	<b>QSM-M3-2-I</b>	10
	M3	3 (outside)	3	<b>133001</b>	<b>QSM-M3-3-I-R</b>	
Barbed fitting CN			Technical data → Internet: cn			
	M3	2 (inside)	3	<b>15871</b>	<b>CN-M3-PK-2</b>	10
	M3	3 (inside)	3	<b>15872</b>	<b>CN-M3-PK-3</b>	
Barbed L-fitting LCN			Technical data → Internet: lcn			
	M3	2 (inside)	2	<b>30491</b>	<b>LCN-M3-PK-2-B</b>	10
	M3	3 (inside)	2	<b>30982</b>	<b>LCN-M3-PK-3</b>	
For connecting vacuum or compressed air to the slide						
Push-in L-fitting QSML			Technical data → Internet: qsml			
	M3	2 (outside)	2	<b>133030</b>	<b>QSML-M3-2</b>	10
	M3	3 (outside)	2	<b>153330</b>	<b>QSML-M3-3</b>	10
	M3	3 (outside)	2	<b>130768</b>	<b>QSML-M3-3-100</b>	100
Barbed L-fitting LCN			Technical data → Internet: lcn			
	M3	2 (inside)	2	<b>30491</b>	<b>LCN-M3-PK-2-B</b>	10
	M3	3 (inside)	2	<b>30982</b>	<b>LCN-M3-PK-3</b>	



# Mini slides DGSC

Technical data

Ordering data – One-way flow control valve						
Type	Connection	Function	Weight [g]	Part No.	Type	PU <sup>1)</sup>
	Male thread					
For supplying compressed air to the mini slide <span style="float: right;">Technical data → Internet: grl</span>						
	M3	Exhaust air flow control	3	<b>175038</b>	<b>GRLA-M3</b>	1
	M3	Supply air flow control	3	<b>175040</b>	<b>GRLZ-M3</b>	

Ordering data – Suction cup						Technical data → Internet: suction cup	
Type	Connection	For suction cup Ø [mm]	Material	Weight [g]	Part No.	Type	PU <sup>1)</sup>
	Thread						
	M5	8	Nitrile rubber	4	<b>34588</b>	<b>VAS-8-M5-NBR</b>	1
	M5	8	Polyurethane	4	<b>1396086</b>	<b>VAS-8-M5-PUR-B</b>	
	M5	8	Silicone	2	<b>1377781</b>	<b>VAS-8-M5-SI-B</b>	

1) Packaging unit

# Festo - Your Partner in Automation



**1 Festo Inc.**  
5300 Explorer Drive  
Mississauga, ON L4W 5G4  
Canada

**Festo Customer Interaction Center**  
Tel: 1 877 463 3786  
Fax: 1 877 393 3786  
Email: [customer.service.ca@festo.com](mailto:customer.service.ca@festo.com)



**2 Festo Pneumatic**  
Av. Ceylán 3,  
Col. Tequesquináhuac  
54020 Tlalneantla,  
Estado de México

**Multinational Contact Center**  
01 800 337 8669  
[ventas.mexico@festo.com](mailto:ventas.mexico@festo.com)



**3 Festo Corporation**  
1377 Motor Parkway  
Suite 310  
Islandia, NY 11749

**Festo Customer Interaction Center**  
1 800 993 3786  
1 800 963 3786  
[customer.service.us@festo.com](mailto:customer.service.us@festo.com)



**4 Regional Service Center**  
7777 Columbia Road  
Mason, OH 45040

Connect with us



[www.festo.com/socialmedia](http://www.festo.com/socialmedia)



[www.festo.com](http://www.festo.com)

Subject to change