



DSR3

ROLLER CAM OPERATED DIRECTIONAL CONTROL VALVE SERIES 11

SUBPLATE MOUNTING
ISO 4401-03 (CETOP 03)

p max 350 bar
Q nom 75 l/min

MOUNTING INTERFACE

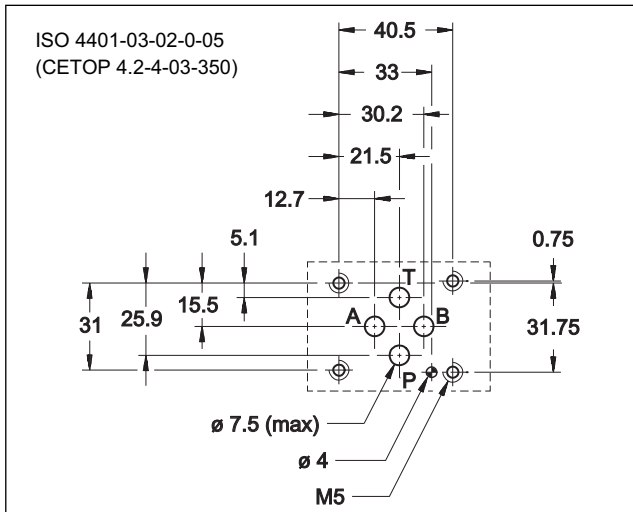

PERFORMANCE RATINGS

(obtained with mineral oil with viscosity of 36 cSt at 50°C)

Maximum operating pressure: - P A B ports - T ports	bar	350 25
Nominal flow rate	l/min	75
Pressure drop $\Delta p-Q$	see par. 4	
Operating limits	see par. 5	
Ambient temperature range	°C	-20 / +50
Fluid temperature range	°C	-20 / +80
Fluid viscosity range	cSt	10 + 400
Fluid contamination degree	according to ISO 4406: 1999 class 20/18/15	
Recommended viscosity	cSt	25
Mass:		
DSR3L-TA	kg	1,1
DSR3L-R	kg	1,2
DSR3H-TA	kg	1,2

OPERATING PRINCIPLE

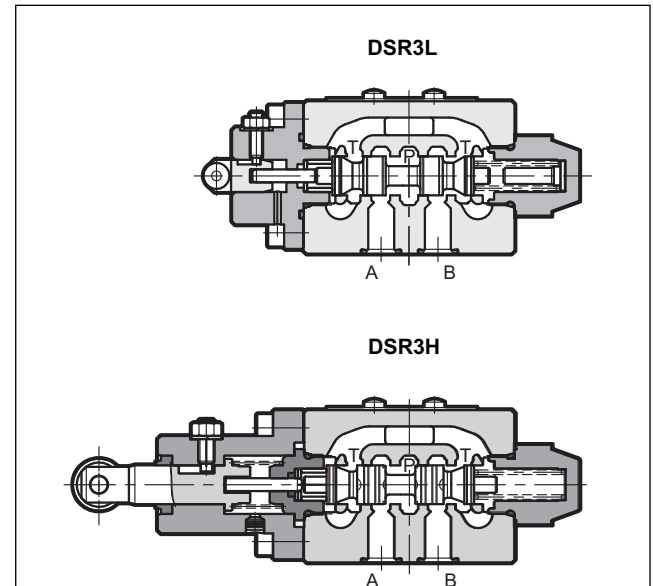

- The DSR3* are roller cam operated directional control valves, available with 4 ways, with mounting interface according to ISO 4401 (CETOP RP121H) standards.
- The valve body is made with high strength iron castings provided with wide internal passages in order to minimize the flow pressure drop.
- It is available in LIGHT (short) and HEAVY DUTY (long) versions, with 2 positions with return spring or with 2 positions with double mechanical command.
- The roller of the valve operating device can be positioned at 90° with respect to the valve mounting surface, in order to achieve flexible installation.
- This type of valve can be used as a hydraulic stroke end for cylinders, speed selectors (not compensated), hydraulic safety devices, directional control of hydraulic axes.

1 - IDENTIFICATION CODE

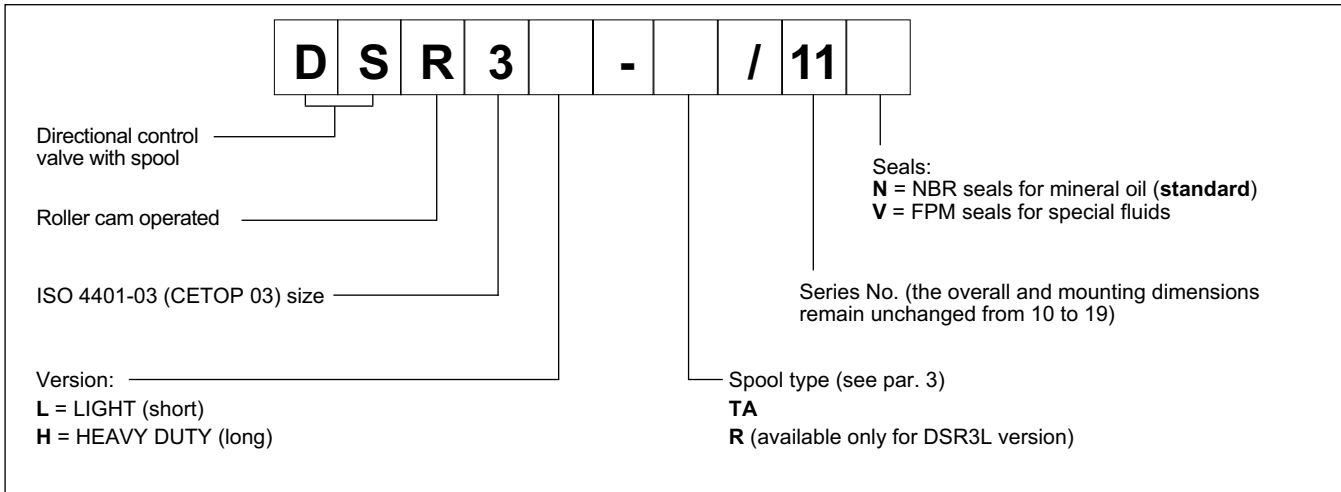

2 - HYDRAULIC FLUIDS

Use mineral oil-based hydraulic fluids HL or HM type, according to ISO 6743-4. For these fluids, use NBR seals. For fluids HFDR type (phosphate esters) use FPM seals (code V). For the use of other kinds of fluid such as HFA, HFB, HFC, please consult our technical department.

Using fluids at temperatures higher than 80 °C causes a faster degradation of the fluid and of the seals characteristics. The fluid must be preserved in its physical and chemical characteristics.

3 - SPOOL TYPE

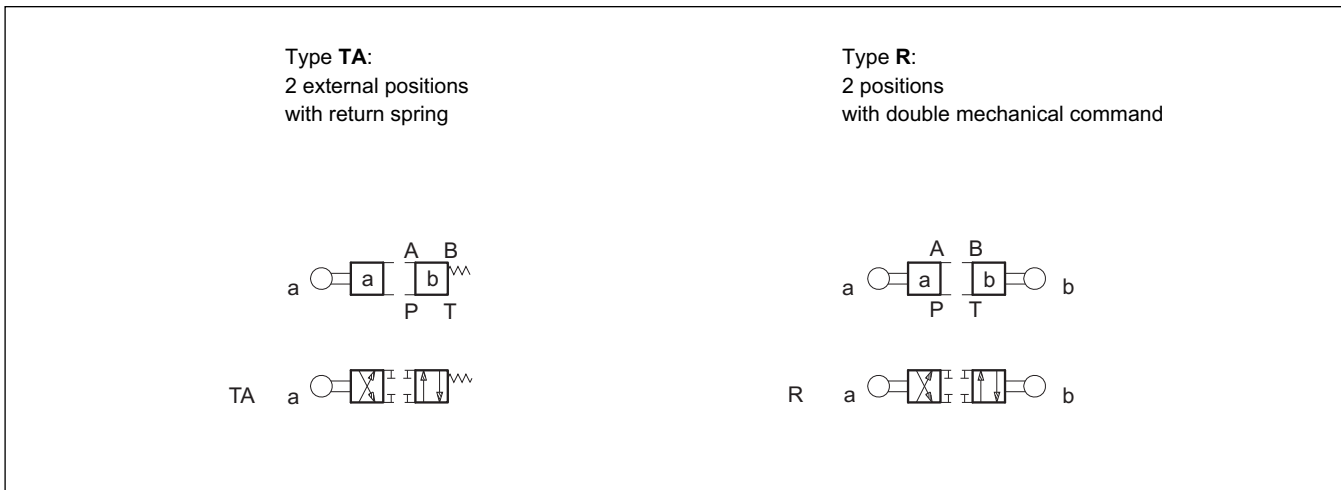

4 - PRESSURE DROPS Δp -Q (obtained with viscosity 36 cSt at 50 °C)

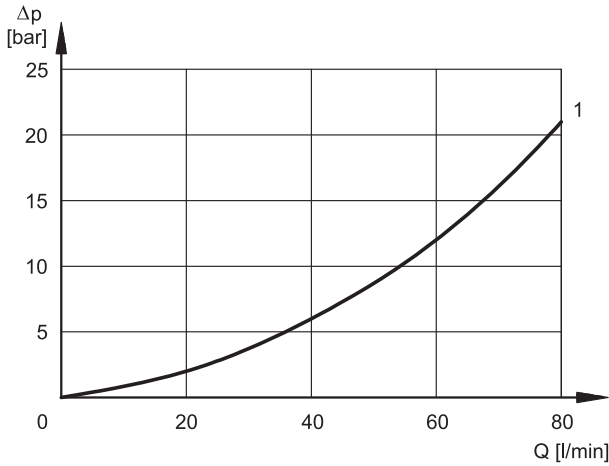

SPOOL TYPE	FLOW DIRECTION			
	P→A	P→B	A→T	B→T
	CURVES ON GRAPH			
DSR3L-TA	1	1	1	1
DSR3L-R	1	1	1	1
DSR3H-TA	1	1	1	1

5 - OPERATING LIMITS

The curves define the flow rate operating fields according to the valve pressure of the different versions. The values have been obtained according to ISO 6403 norm, with mineral oil viscosity 36 cSt at 50 °C and filtration according to ISO 4406:1999 class 18/16/13.

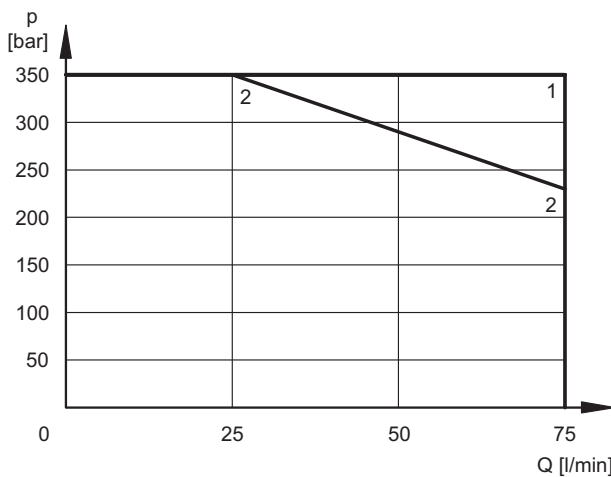

SPOOL TYPE	CURVE	
	P→A	P→B
DSR3L-TA	2	2
DSR3L-R	1	1
DSR3H-TA	1	1

6 - INSTALLATION

Configurations with centering and return springs can be mounted in any position; type R valves - without springs - must be mounted with the longitudinal axis horizontal. Valve fixing is by means of screws or tie rods, with the valve mounted on a lapped surface, with values of planarity and smoothness that are equal to or better than those indicated in the drawing. If the minimum values of planarity and/or smoothness are not met, fluid leakage between valve and mounting surface can easily occur.

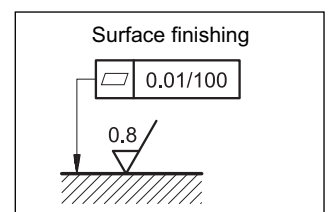

7 - OVERALL AND MOUNTING DIMENSIONS

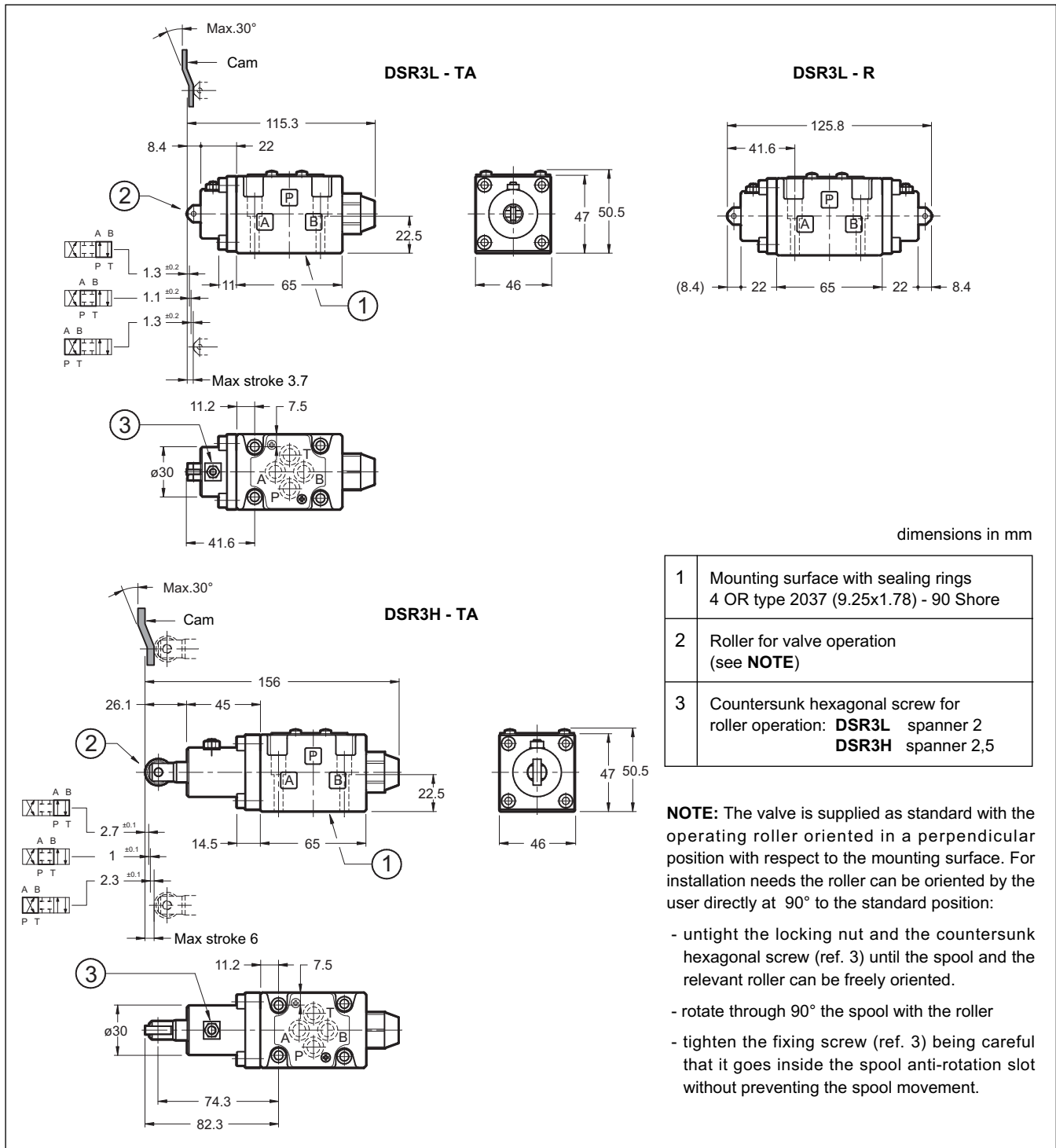

8 - VALVE FASTENING BOLTS

N. 4 fastening bolts SHC ISO 4762 M5x30
Tightening torque 5 Nm (bolts A 8.8)

9 - SUBPLATES (see catalogue 51 000)

Type PMMD-AI3G with rear ports 3/8" BSP

Type PMMD-AL3G with side ports 3/8" BSP